



LifeStyle Small (XDLS)

Outdoor Decorative Area Light



OVERVIEW

Lumen Package (lm)	6,000 - 9,000
Wattage Range (W)	76 - 106
Efficacy Range (LPW)	72 - 99
Weight lbs (kg)	24 (10.8)

QUICK LINKS

FEATURES & SPECIFICATIONS

Construction

- Cast aluminum. Wiring emerges from crown through compression seal fitting to prevent water entry. One-piece silicone gasket seals crown to shade for water and dust-tight construction.
- Spun aluminum shade. Two shade styles available - A - Angle and B - Bell.
- Optical unit and aluminum door frame recessed into shade and sealed with one-piece silicone gasket.
- Door frame retaining fasteners are captive.
- Brackets are extruded and cast aluminum assemblies or fabrications. All decorative elements are die cast or extruded aluminum.
- Luminaire is proudly made in the U.S.
- Fixtures are finished with LSI's DuraGrip® polyester powder coat finishing process. The DuraGrip finish withstands extreme weather changes without cracking or peeling. Other standard LSI finishes available. Consult factory.
- Shipping weight: 24 lbs in carton.

Optical System

- Select high-brightness LEDs in Cool White (5000K), Neutral White (4000K) or Warm White (3500K) color temperature. 70 CRI CW, 80 CRI NW and WW.
- Types 3, 5 and FT available.

- Clear tempered flat glass lens sealed with silicone gasket to door frame (includes pressure-stabilizing breather).
- Optical unit is tethered and provides access to driver.
- Zero uplight.

Electrical

- LSI drivers feature integral sensor which reduces drive current when ambient temperatures exceed rated temperature.
- Two-stage surge protection (including separate surge protection built into electronic driver) meets IEEE C62.41.2-2002, Location Category C. Available with universal voltage power supply 120-277VAC (UE - 50/60Hz input), and 347-480VAC.
- Available in SS (Super Saver) and HO (High Output) drive currents (Drive currents are factory programmed).
- Components are fully encased in potting material for moisture resistance.
- Driver complies with FCC standards. Driver and key electronic components can easily be accessed.
- Operating temperature: -40°C to +50°C (-40°F to +122°F).
- 0-10V dimming (10% - 100%) Optional.

Controls

- Optional button-type photocells (PCI) are available in 120, 208, 240, 277 or 347 volt (supply voltage must be specified).

Installation

- Classic Hook (CH) and Side Arm (SA - 4" O.D. minimum pole top required) available. See Steel Round Pole and Aluminum Round Pole data sheets for pole selection information.
- Side Arm pole mount requires LSI B3 reduced drilling pattern.
- Classic hook mount requires a 4" O.D. pole or tenon.

Warranty

- LSI luminaires carry a 5-year limited warranty. Refer to <https://www.lsicorp.com/resources/terms-conditions-warranty/> for more information.

Listings

- Listed to UL 1598 and UL 8750.
- Suitable for wet Locations.
- US patent 7,828,456 8,002,428, 8,177,386 8,434,893
- Specifications and dimensions subject to change without notice.

LifeStyle Small (XDLS) Outdoor Decorative Area Light

Type : _____

 Have questions? Call us at (800) 436-7800

ORDERING GUIDE

TYPICAL ORDER EXAMPLE: XDLS B 3 LED SS NW UE BLK CH S PCI120																
Prefix	Distribution	Light Source	Lumen Package	Color Temperature	Voltage	Finish	Mounting Style ^{2,3}	Mounting Style ^{2,3}	Options							
XDLSA - LifeStyle Angle Shade ¹	3 - Type 3	LED	SS - Super Saver (6,000 Nominal Lumens)	WW - Warm White (3,500K CCT)	UE - Universal Voltage (120 - 277V)	BLK - Black	CH - Classic Hook	S - Single	PCI120 - 120V Button-Type Photocell							
XDLSB - LifeStyle Bell Shade ¹	4 - Type 4 (Forward Throw)									HO - High Output (9,000 Nominal Lumens)	NW - Neutral White (4,000K CCT)	347-480 - High Voltage (347 - 480V)	BRZ - Bronze	SA4 - Side Arm Mount for 4" O.D. Round Poles ³	D180 - Double @ 180°	PCI208-277 - 208-277V Button-Type Photocell
	5 - Type 5															
								Q90 - Quad ⁴	DIM - 0-10 Volt Dimming (from external signal)							
						GMG - Gun Metal Grey		TN120 - Triple @ 120° ⁴								
						MSV - Metallic Silver		W - Wall Mount								
						PLP - Platinum Plus										
						SVG - Satin Verde Green										



Need more information?
[Click here for our glossary.](#)

Have additional questions?
Call us at (800) 436-7800



ACCESSORY ORDERING INFORMATION

Part Number	Description
FK120	Single Fusing (120V) ⁵
FK277	Single Fusing (277V) ⁵
DFK480	Double Fusing (480V) ⁵
DFK347	Double Fusing (347V) ⁵

PERFORMANCE

Delivered Lumens ⁶												
Lumen Package	Distribution	CRI	3000K			4000K			5000K			Wattage
			Delivered Lumens	Efficacy	BUG Rating	Delivered Lumens	Efficacy	BUG Rating	Delivered Lumens	Efficacy	BUG Rating	
SS	3	70	7,096	99	B1-U0-G1	7,096	99	B1-U0-G1	4,790	67	B1-U0-G1	71
	FT		6,543	92	B1-U0-G2	5,846	83	B1-U0-G2	5,171	74	B1-U0-G1	
	5		6,225	88	B3-U0-G1	5,685	80	B2-U0-G1	5,007	72	B2-U0-G1	
HO	3	70	9,603	91	B2-U0-G2	8,810	83	B2-U0-G2	6,460	61	B2-U0-G2	106
	FT		8,994	85	B1-U0-G2	7,891	76	B1-U0-G2	6,880	65	B1-U0-G2	
	5		8,501	98	B3-U0-G2	7,779	75	B3-U0-G1	6,740	64	B3-U0-G1	

1 When ordering a multiple configuration (D180, etc.) order one fixture/bracket configuration per pole - i.e. order one XDLSB 3 LED SS CW UE BLK CH D180 PCI120 to receive two fixtures and one CH D180 bracket (see drawing on this page). See STEEL ROUND POLES and ALUMINUM ROUND POLES data sheets for pole ordering information.

2 See Lifestyle Bracket ordering chart for Mounting Style/Configurations availability.

3 B3 reduced drilling pattern required.

4 For use with SA4 and SA5 mounting styles only.

5 Fusing must be located in the hand hole of pole.

6 LEDs are frequently updated therefore values are nominal

LifeStyle Small (XDLS) Outdoor Decorative Area Light

Type: _____

 Have questions? Call us at (800) 436-7800

PRODUCT DIMENSIONS

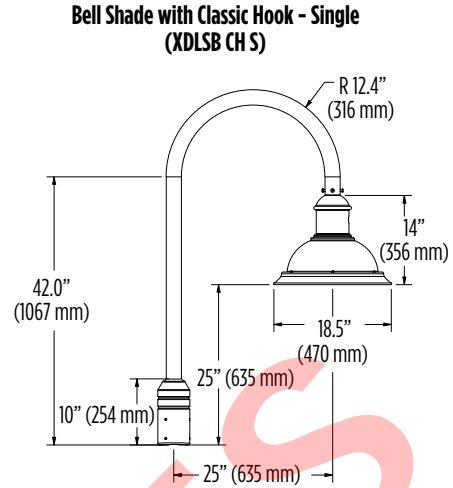
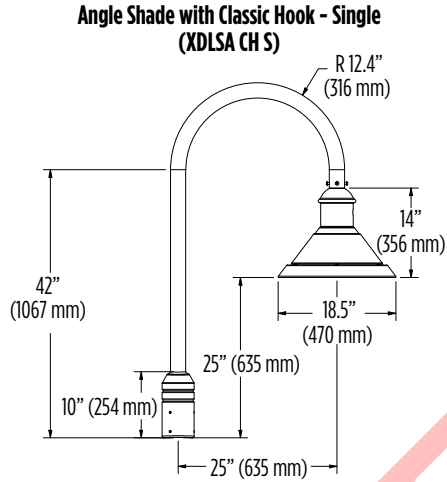

Angle Shade with Side Arm Mount for 4" Round Poles - Single (XDLSA SA4 S)

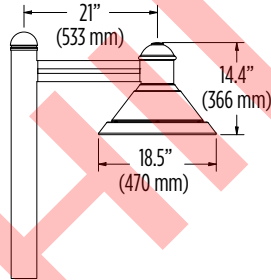

Bell Shade with Side Arm Mount for 4" Round Poles - Single (XDLSB SA4 S)

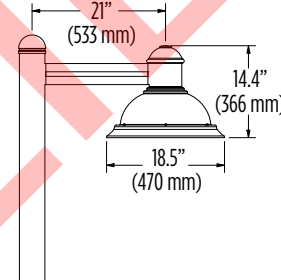

Classic Hook - Double 180° (CHD180)

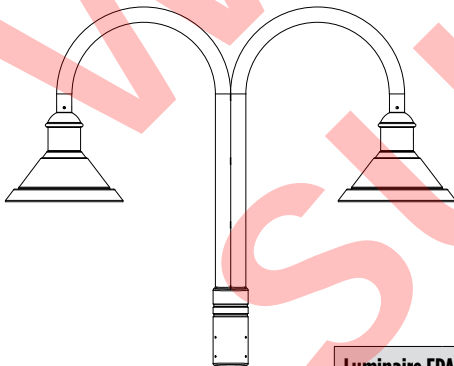



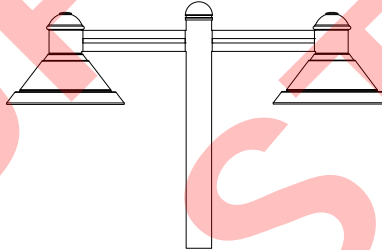

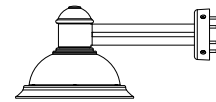

Side Arm Mount - Double 180° (SAD180)



Side Arm Mount - Wall Mount' (SAW)



Luminaire EPA Chart - XDLS ²						
Configuration	 Single	 D180°	 D90°	 T90°	 TN120°	 Q90°
EPA	1.6	2.7	2.3	3.3	3.4	4.1

1 See Lifestyle Brackets and Mounts in outdoor section of latest Buyers Guide for details on other bracket sizes.

2 Includes Bracket.

LifeStyle Small (XDLS) Outdoor Decorative Area Light

Type: _____

 **Have questions?** Call us at (800) 436-7800

POLES & BRACKETS

LSI offers a full line of poles and mounting accessories to complete your lighting assembly. Aluminum and steel in both square and round shafts. In addition, LSI offers round tapered, fluted and hinge based poles. Designed and engineered for durability and protected with our oven baked DuraGrip Protection System. Also available with our DuraGrip+ Protection system for unmatched corrosion resistance and an extended warranty. American made in our Ohio facility with industry leading lead times.

[Click here to learn more details about poles & brackets](#)



Decorative Base Cover Round Straight

Optional decorative base cover has a two-piece die cast construction with stainless steel fasteners. Base cover is polyester powder coated to match pole. GBC base cover fits 4" and 5" diameter straight round poles. Includes 4" round pole adaptor molded from black silicone rubber.



Spun Aluminum Collar Round Straight

Optional one-piece spun aluminum collar for 4" or 5" diameter straight round poles. Features durable, high quality construction with aesthetically pleasing design that slips over the pole for increased theft deterrent.



Square Pole
14'-39'

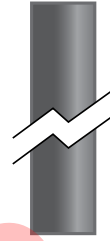

Round Pole
10'-30'

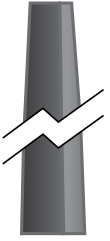

Tapered Pole
20'-39'