



The Advance Xitanium range of linear LED drivers is designed to provide OEMs with ultimate flexibility. These models are compatible with standard 0-10V dimming systems to deliver reliably smooth dimming performance down to a minimum of 1%. Enabled with SimpleSet technology, these drivers offer the needed flexibility and performance for the application with precise tuning of drive currents, selectable dimming curves and adjustable minimum dimming levels. With wide operating windows, slim profile and simple current adjustability, the drivers make it easy for luminaire manufacturers to design linear fixtures with desired lumen levels to suit the application.

Specifications

Input Voltage (Vac)	Output Power (W)	Output Voltage (V)	Output Current (A)	Efficiency @ Max Load	Max Case Temp. (°C) Life/UL	Input Current (A)	Input Power (W)	THD @ Max Load (%)	Power Factor @ Max Load	Surge Protect (Ring Wave, KV)	Dimming	Dimming Range (%)	Min Dimming Current (mA)	Drive Type
120	20	10-54	0.1-0.7	86.0	75 / 85	0.2	23	<15	>0.95	2.5	0-10V	1-100	1.5	CC
277				87.0		0.09		<15						

Enclosure

Item	In(mm)	Tolerance (mm)
Overall length (A1)	11.02(280)	+/-0.5
Mounting Length (A2)	10.63(270)	+/-0.5
Case Length (A3)	8.81(223.8)	+/-0.5
Case Width (B1)	1.16(29.4)	+/-0.5
Case Height (C1)	1(25.4)	+/-1
Mounting Hole Diameter (D1)	0.31(7.9)	+/-0.3
Center of SimpleSet antenna (G1)	0.8(20.4)	+/-3

Mechanical Diagram

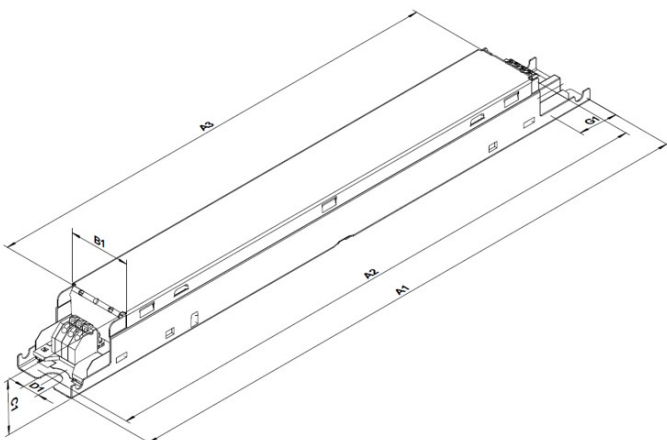

Wiring Diagram

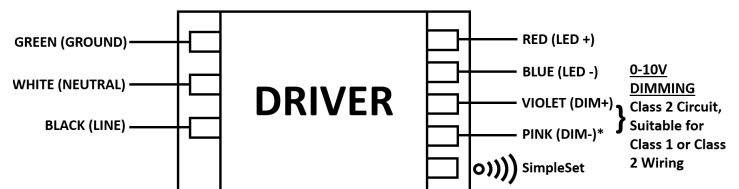

- Install in accordance with national and local electrical codes.
- The field-wiring leads or push-in terminals shall be fully enclosed.
- Use 18 AWG Solid Copper Wire Rated ≥ 90 °C.
- Strip Wire 3/8".
- For Class 2 Wiring, Use 20 AWG-16 AWG.
- Driver case must be grounded.

XI020C070V054BST5

Features

- 50,000+ hour lifetime
- SimpleSet programmable
- Large operating window
- 1% minimum dim level
- Constant Current Reduction (CCR) Dimming

Benefits

- Slim profile housing enables easy design-in with excellent thermal performance
- Enables simple, fast, flexible application-specific configurations
- Enables fixture designs with comprehensive application coverage for various loads and lumen levels

Application

- Indoor linear applications such as troffers and pendants
- Office
- Education
- Healthcare
- Retail
- Hospitality

Logistical data

Specification item	Value
Product name	XI020C070V054BST5
EOC	XI020C070V054BST5
Logistic code 12NC	9290 027 79913
Product code	XI020C070V054BST5M
Pieces per box	18
Weight	210 gram

All the specifications are typical and at $T_{\text{ambient}} = 25^{\circ}\text{C}$ unless specified otherwise

Electrical input data

Specification item	Value	Value	Unit	Condition
Rated input voltage range	108...305		V_{ac}	Performance range
Rated input voltage	120	277	V_{ac}	
Rated input frequency	50...60	50...60	Hz	Performance range
Rated input current	0.2	0.09	A	@ rated output power @ rated input voltage
Rated input power	23.0	23.0	W	@ rated output power @ rated input voltage
Efficiency	86.0	87.0	%	@ rated output power @ rated input voltage

Electrical output data

Specification item	Value	Unit	Condition
Output voltage	10...54	V_{dc}	Class 2 Output
Output voltage max.	60	V	Open Circuit Voltage
Output current	100...700	mA	
Output current min programmable	100	mA	
Min output current	1.5	mA	
Output current tolerance \pm	5	%	within performance window
Output current ripple LF	≤ 15	%	@ max lout
Output current ripple HF	≤ 4	%	@ frequency range 60Hz-3KHz
Output power	0.1...20.0	W	
Minimum performance output power	10	W	Power factor > 0.9 and THD < 20%

XI020C070V054BST5

Control interfaces

Specification item	Value	Unit	Condition
Control method	0-10V		
Dimming range	1...100	%	Default range
Dimming Source Current	0.25	mA	max source current across entire dimming range
Maximum Dimming Voltage	12	V	
Dimming Leakage Current	0.01	mA	Max number of driver in parallel, refer to Design-in Guide

Isolation

U=Max. Input Voltage

Isolation per UL-8750	Input	Output	0-10V	Enclosure
Input	-	2U + 1kVac	2U + 1kVac	2U + 1kVac
Output	2U + 1kVac	-	2U + 1kVac	500Vac
0-10V	2U + 1kVac	2U + 1kVac	-	2U + 1kVac
Enclosure	2U + 1kVac	500Vac	2U + 1kVac	-

Operational temperatures and humidity

Specification item	Value	Unit	Condition
Ambient temperature	-20...+50	°C	Higher ambient temperature allowed as long as T _{case-max} is not exceeded
T _{case-UL}	85	°C	Max. temperature measured at T _{case} -point
T _{case-life}	75	°C	C10 = 50000 hours measured at T _c -point

Lifetime

Specification item	Value	Unit	Condition
Driver lifetime	50,000	hours	Measured temperature at T _{case} is T _{case-life}

XI020C070V054BST5

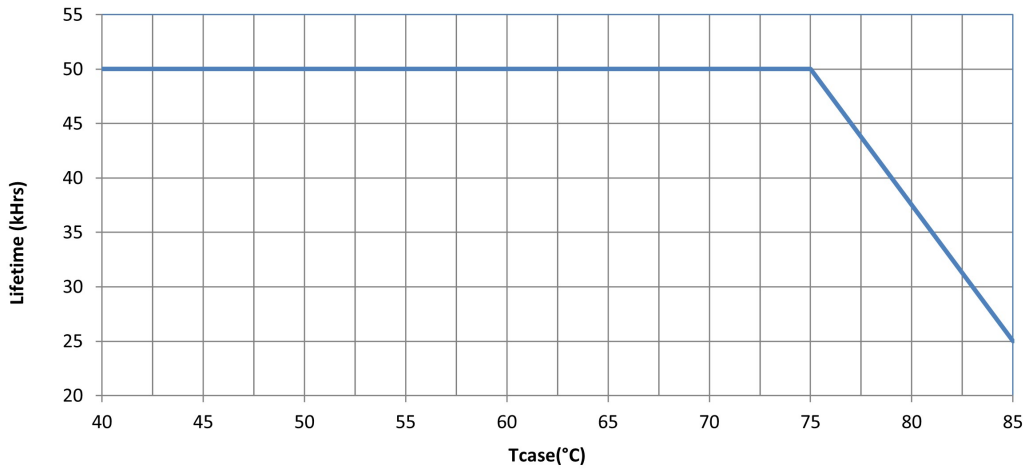

Maximum failures = 10%

Programmable features

Specification item	Available	Default setting	Condition
Set Adjustable Output Current (AOC)	NFC, SimpleSet	700 mA	
Adjustable Light Output (ALO)	Yes		
0-10V	Yes		
Min Dim Level (%)	Yes		
Min Dim Current	Yes		
Dim to off	Yes		
Dimming curve selection	Linear or logarithmic	linear	
OEM Write Protection (OWP)	Yes		

Non-programmable features

Specification item	Value	Condition
Open load protection	Yes	
Short circuit protection	Yes	
Over power protection	Yes	
Overtemperature protection	Yes	

XI020C070V054BST5

Inrush current

Specification item	Value	Unit	Condition
Inrush current	7	A	Input voltage 120V
Inrush current	20.1	A	Input voltage 277V
Inrush peak width	9.2	μ s	Input voltage 120V, measured at 10% height
Inrush peak width	9	μ s	Input voltage 277V, measured at 10% height

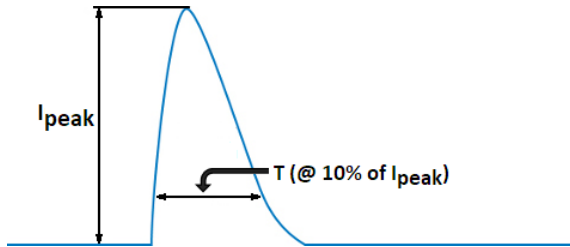

Surge immunity

Specification item	Value	Unit	Condition
Mains surge immunity (diff. mode)	2.5	kV	ANSI Surge Type 100kHz Ring Wave (w/t 30 ohm)
Mains surge immunity (comm. mode)	2.5	kV	ANSI Surge Type 100kHz Ring Wave (w/t 30 ohm)

Approbation

Specification item	Value
Approval Marks / Agency Approbations	NOM / RoHS / UL Class P / UL Listed US & Can
EMI standards	FCC Title 47 Part 15; Class A
Environmental protection rating	UL damp & dry
Audible Noise	<24dB Class A

XI020C070V054BST5

Graphs

Operating window

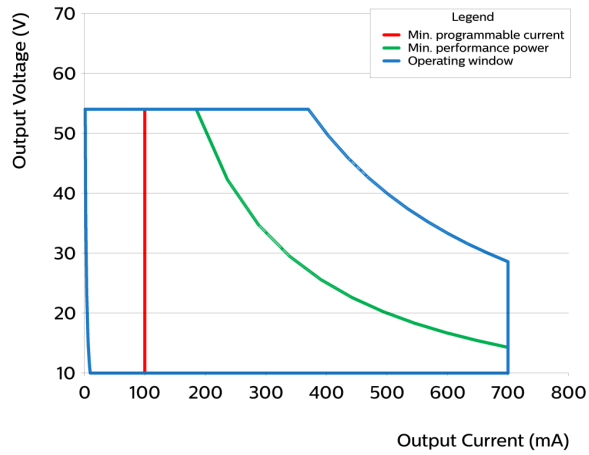

- Factory default output current is 0.7A.
- To get a 100% to 1% dimming range, the output current setting through AOC should be $\geq 0.15A$.
- Factory default minimum dimming is 1%. This can be adjusted between 1% and 100% using Advance MultiOne.

Over Temperature Protection

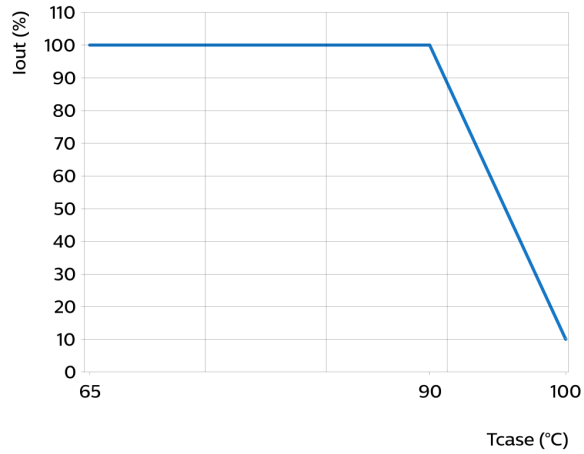

XI020C070V054BST5

Power factor versus output power

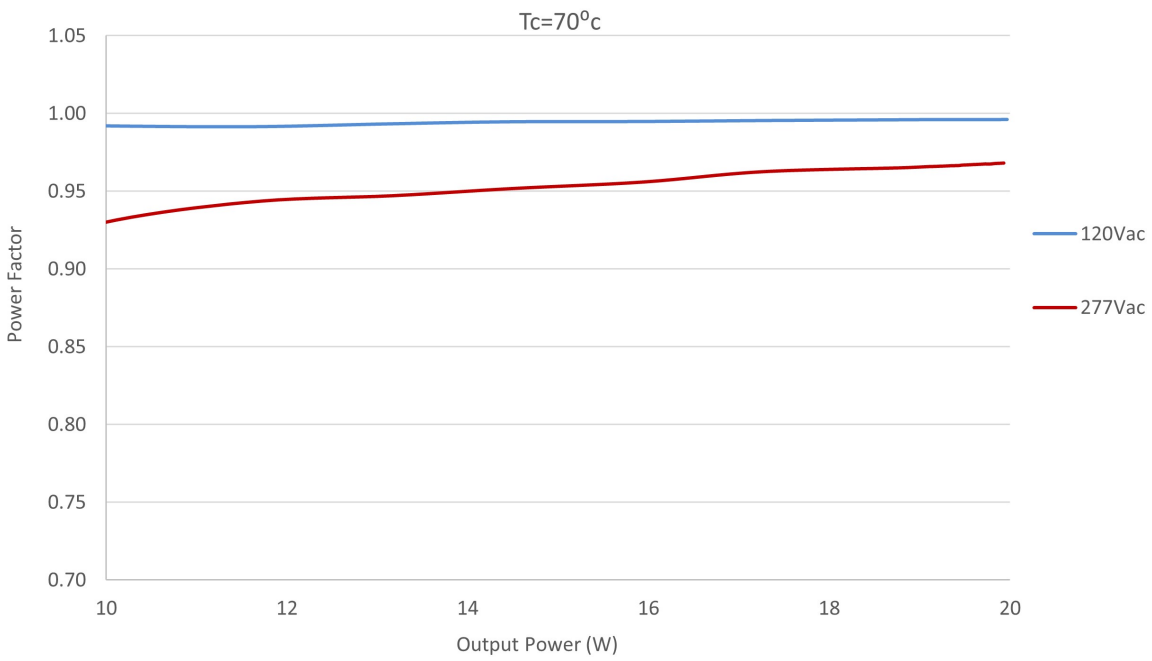

THD versus output power

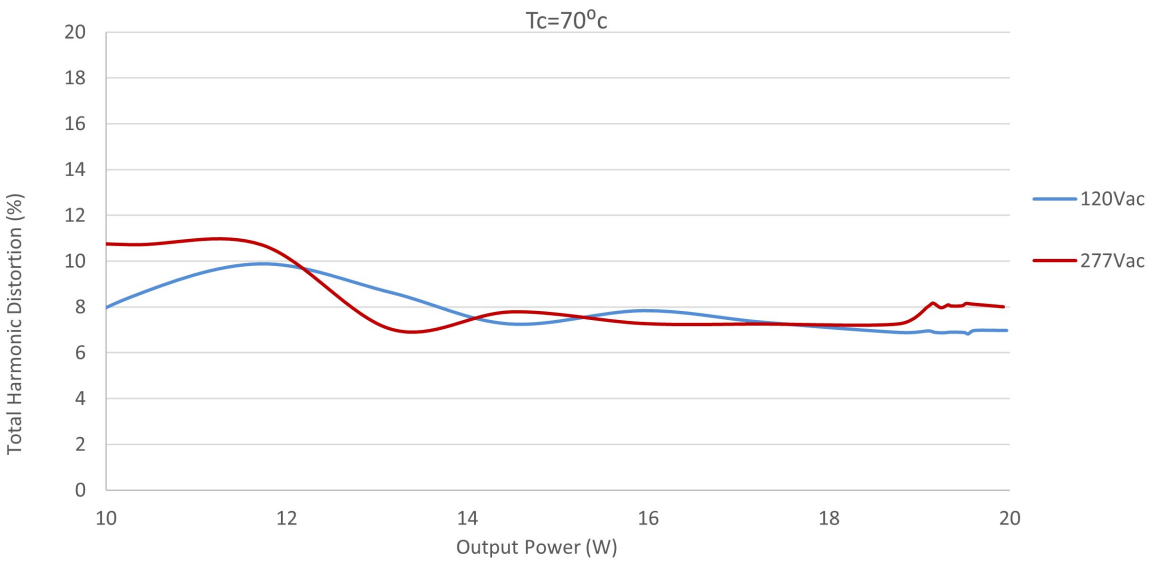

XI020C070V054BST5

I_{out} as function of 0-10V interface

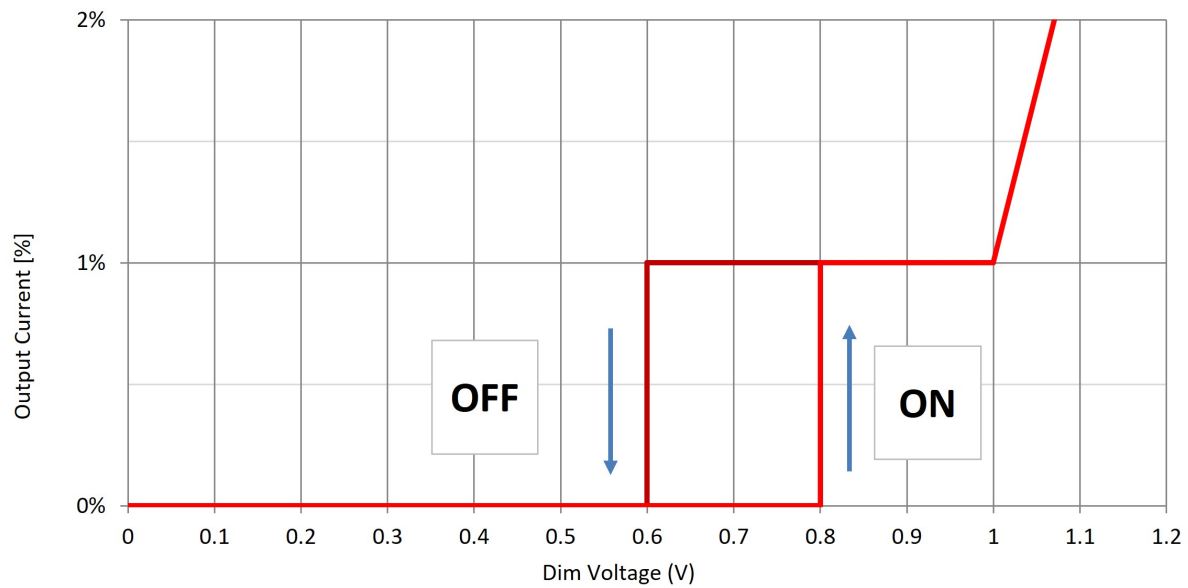
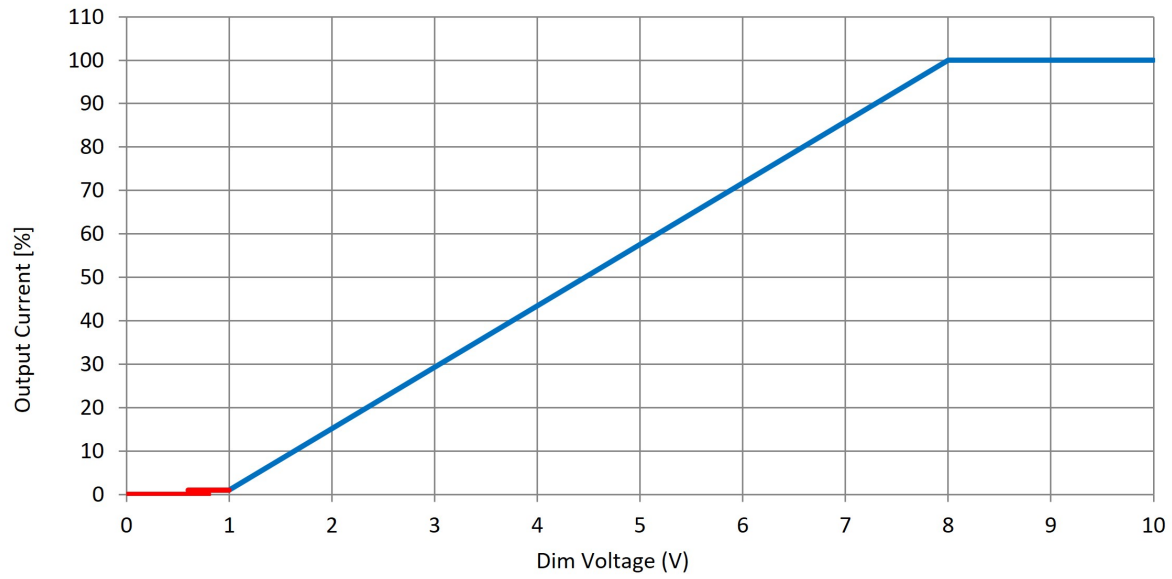

XI020C070V054BST5

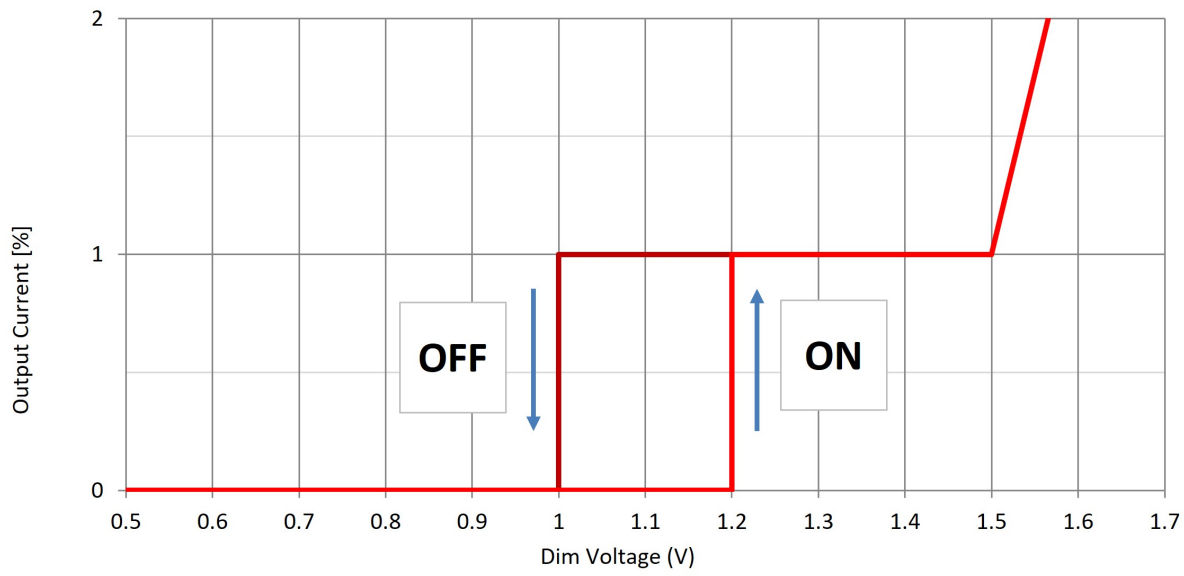
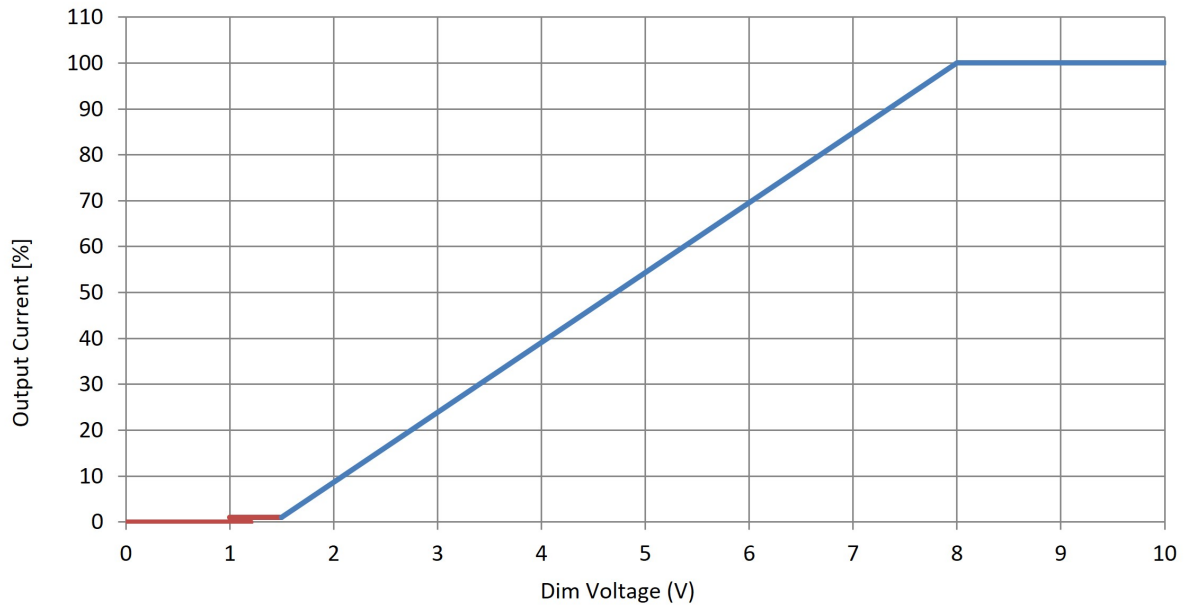

XI020C070V054BST5

Efficiency as function of V_{out}

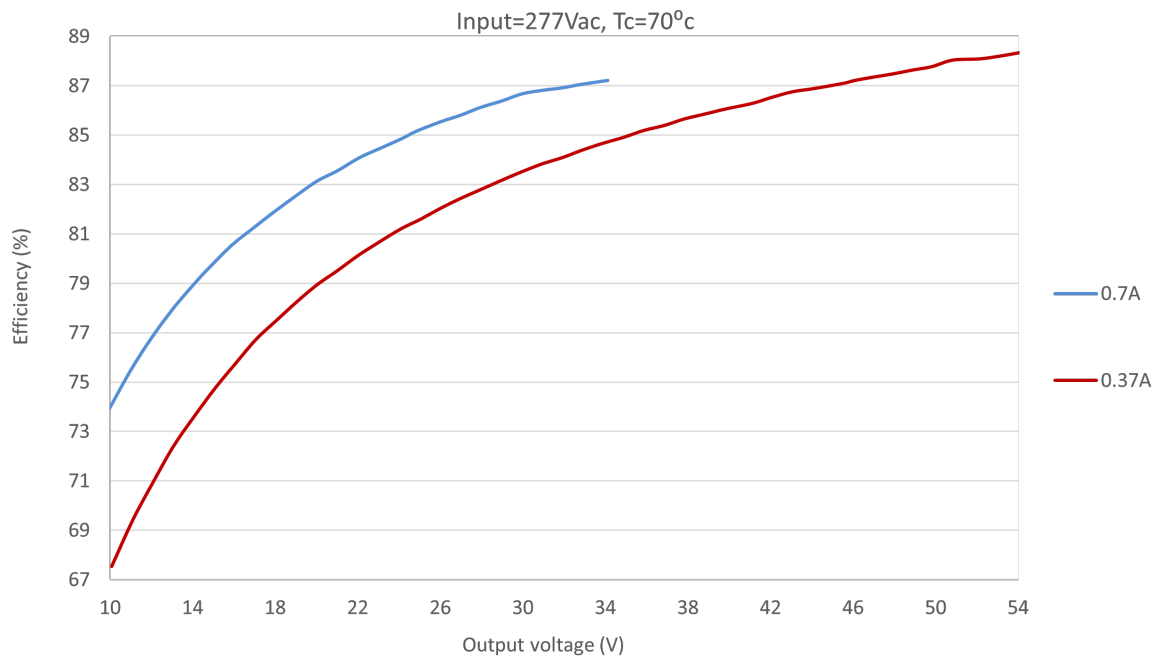
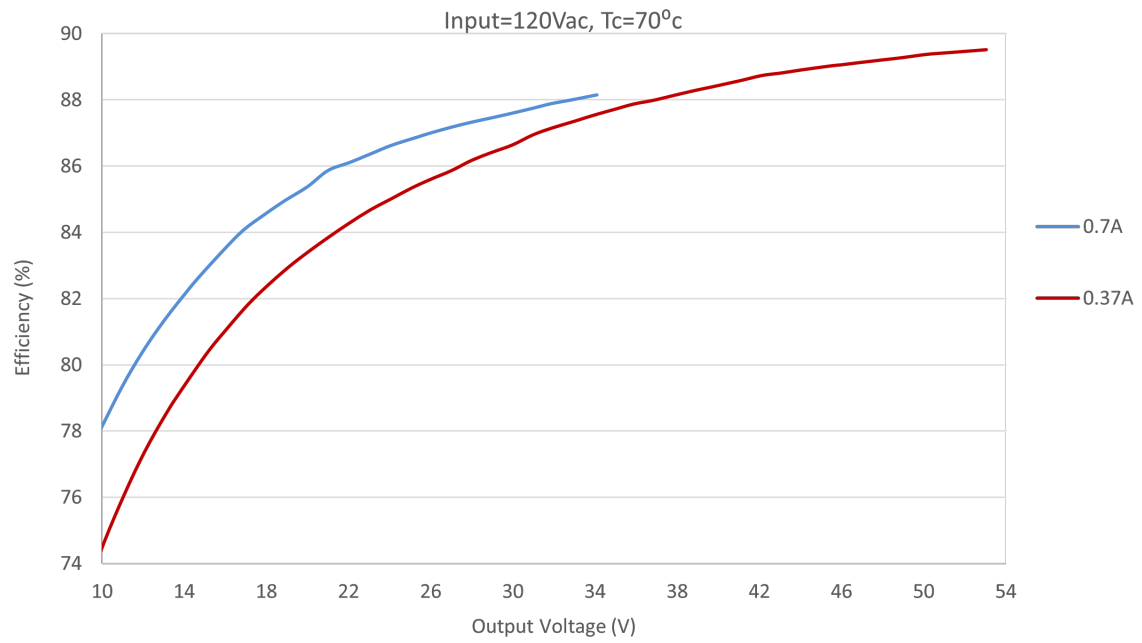

Approved Dimmer List

Manufacturer	Manufacturer Part Number
Lutron	Visit www.lutron.com/advance for a list of dimmers (Mark VII) that will work with this driver
Leviton	IllumaTech IP7 series
Philips	Sunrise - SR1200ZTUNV

0.5V Dim to Off (factory default)

Symbol	Parameter	Min	Typical	Max	Unit
Von	Turn on threshold	0.7	0.8	0.9	V
Voff	Turn off threshold	0.5	0.6	0.7	V
Ton	Turn on time			400	mS
Toff	Turn off time			400	mS

1.0V Dim to Off (traditional dimmer)

Symbol	Parameter	Min	Typical	Max	Unit
Von	Turn on threshold	1.1	1.2	1.3	V
Voff	Turn off threshold	0.9	1	1.1	V
Ton	Turn on time			400	mS
Toff	Turn off time			400	mS

