

# XR3nc

## X-SERIES | XM20 | 3-INCH ROUND RECESSED DOWNLIGHT

PROJECT \_\_\_\_\_

TYPE \_\_\_\_\_

SPECIFICATION \_\_\_\_\_

- Fixed housing for downlight and pinhole; Universal housing for adjustable and wall wash options
  - Internally adjustable with dual locking; 360° rotation and 40° aiming
  - Field-replaceable LED module with integrated driver; no tools needed
  - 120 V standard
  - 50,000 hours (L70)
  - RoHs-compliant
  - UL Certified for dry locations
  - Contain no lead or mercury
  - 0-10 V\*, Triac and ELV dimming; compatibility list available
  - Designed for new construction ceiling installation
  - Non-IC rated; insulation must be kept 3" from sides and 1" above housing
  - VioLight and \*MonoWhite color rendering enhancements available
  - \*90+ High CRI available.
- To order, replace 'K' in CCT designation with 'h' in ordering code.

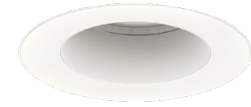

### Ordering Information

Example: XR3nc/D/Xm20/15m/30K/1450/BK/WH

Fixture	Type	Module	Beam Spread	CCT / Lumens	Options + Accessories
XR3nc	D - Downlight A - Adjustable P - Pinhole <i>(downlight and die-cast with flange only)</i> WW - Lensed Wall Wash <i>(die-cast with flange only)</i>	Xm20	COB-optic 15c 25c 40c 60c <sup>†</sup>	25K* / 1000 27K / 1050 30K / 1100 30m* / 1100 35K* / 1100 35m* / 1100 40K* / 1100  25K* / 1300 27K / 1450 30K / 1500 30m* / 1500 35K* / 1500 35m* / 1500 40K* / 1500  25K* / 1800 27K / 1900 30K / 2000 30m* / 2000 35K* / 2000 35m* / 2000 40K* / 2000	<b>Module Options</b> HL - Honeycomb Louver SL - Linear Spread SP - Prismatic Spread More Accessories Available  <b>Fixture Options</b> O10 - 0-10 V Dimming* EM - Emergency Backup Microinverter*
				<b>Trim Finish (Cone / Flange)</b> Die-cast, Powder Coated WH / WH - White Cone and Flange BK / WH - Black Cone, White Flange SV / WH - Silver Cone, White Flange BK / BK - Black Cone and Flange SV / SV - Silver Cone and Flange BZ / BZ* - Bronze Cone and Flange BZ / WH* - Bronze Cone, White Flange BK / PW* - Black Cone, Perfect White Flange PW / PW* - Perfect White Cone and Flange SV / PW* - Silver Cone, Perfect White Flange  Lensed Die-cast, Powder Coated (downlight only - polycarbonate soft diffusion lens) WHL / WH - Lensed White Cone and Flange BKL / WH - Lensed Black Cone, White Flange SVL / WH - Lensed Silver Cone, White Flange BKL / BK - Lensed Black Cone and Flange SVL / SV - Lensed Silver Cone and Flange BZL / BZ* - Lensed Bronze Cone and Flange BZL / WH* - Lensed Bronze Cone, White Flange PWL / PW* - Lensed Perfect White Cone and Flange BKL / PW* - Lensed Black Cone, Perfect White Flange SVL / PW* - Lensed Silver Cone, Perfect White Flange BZL / PW* - Lensed Bronze Cone, Perfect White Flange	Trimless Die-cast, Powder Coated WH / TR* - White Cone BK / TR* - Black Cone SV / TR* - Silver Cone BZ / TR* - Bronze Cone PW / TR* - Perfect White Cone  Spun Aluminum (downlight only - polycarbonate soft diffusion lens) CL / CL - Clear Specular Cone and Flange SD / SD - Clear Semi-diffuse Cone and Flange CL / WH - Clear Specular Cone, White Flange SD / WH - Clear Semi-diffuse Cone, White Flange CB / CB - Black Specular Cone and Flange DB / DB - Black Semi-diffuse Cone and Flange CB / WH - Black Specular Cone, White Flange DB / WH - Black Semi-diffuse Cone, White Flange CG / CG - Gold Specular Cone and Flange DG / DG - Gold Semi-diffuse Cone and Flange CG / WH - Gold Specular Cone, White Flange DG / WH - Gold Semi-diffuse Cone, White Flange CL / PW* - Clear Specular Cone, Perfect White Flange SD / PW* - Clear Semi-diffuse Cone, Perfect White Flange CB / PW* - Black Specular Cone, Perfect White Flange DB / PW* - Black Semi-diffuse Cone, Perfect White Flange CG / PW* - Gold Specular Cone, Perfect White Flange DG / PW* - Gold Semi-diffuse Cone, Perfect White Flange
			Multi-optic 15m 25m 40m	27K / 1400 30K / 1450 30v / 1450 35K* / 1450 40K* / 1450	
			Specialty 10c	27K / 750 30K / 750	
			Dim-to-Warm 25c 40c	(2700K to 1800K) D27 / 1000	

\*Consult factory for lead time and availability

Notes: Modules are black finish standard. Other finishes are available; consult factory for custom specification.

<sup>†</sup>60c Beam Spread is achieved with 40c optic and WT trim accessories; not available for adjustable trims.

# XR3nc

## X-SERIES | XM20 | 3-INCH ROUND RECESSED DOWNLIGHT

PROJECT \_\_\_\_\_

TYPE \_\_\_\_\_

SPECIFICATION \_\_\_\_\_

UNIVERSAL HOUSNG

TRIM AND TRIMLESS

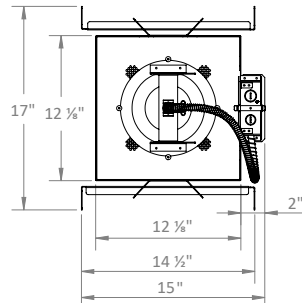

AIMING

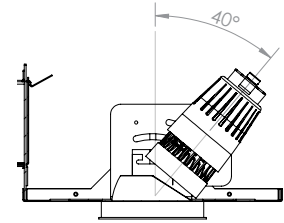

TRIM WITH INTEGRAL FLANGE

Fixture Height: 8"  
Max Ceiling Thickness: 5/8"  
Standard; Other Options\*  
Ceiling Cut-Out: 4 3/8" Diameter  
Weight without module: 7.15 lb

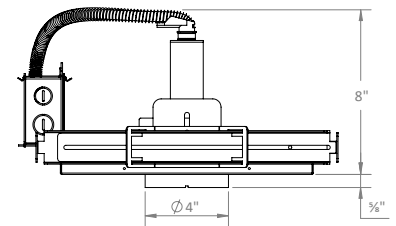

TRIMLESS WITHOUT FLANGE\*

Fixture Height: 8"  
Max Ceiling Thickness: 5/8" Standard; Other Options\*  
Ceiling Cut-Out: 4 3/8" Diameter  
Perforated Mesh Frame: Ø 6 3/16"  
Weight without module: 7.2 lb

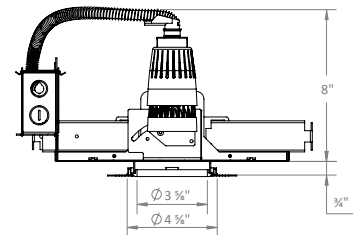

FIXED HOUSNG

TRIM AND TRIMLESS

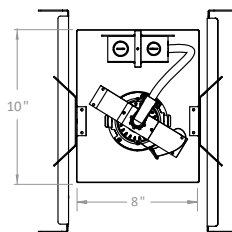

TRIM WITH INTEGRAL FLANGE

Fixture Height: 8"  
Max Ceiling Thickness: 5/8" Standard; Other Options\*  
Ceiling Cut-Out: 4 3/8" Diameter  
Weight without module: 6.9 lb

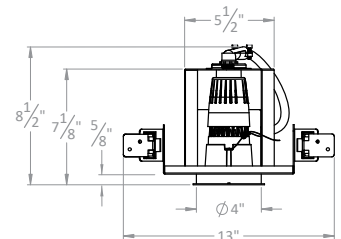
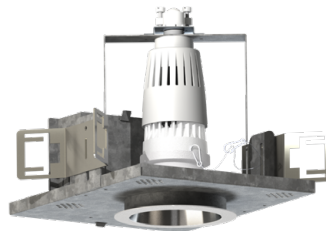

TRIMLESS WITHOUT FLANGE\*

Fixture Height: 8"  
Max Ceiling Thickness: 5/8" Standard; Other Options\*  
Ceiling Cut-Out: 4 3/8" Diameter  
Perforated Mesh Frame: Ø 6 3/16"  
Weight without module: 6.8 lb

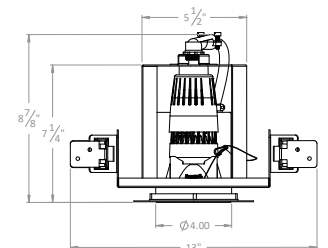
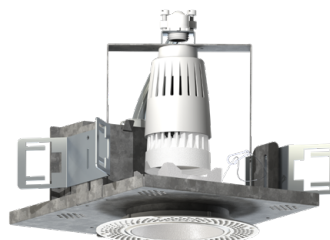

# XR3nc

## X-SERIES | XM20 | 3-INCH ROUND RECESSED DOWNLIGHT

PROJECT \_\_\_\_\_

TYPE \_\_\_\_\_

SPECIFICATION \_\_\_\_\_

**PHOTOMETRIC DETAILS | baseline X output multiplier X cri-cct multiplier = final output**

COB OPTIC: Baseline for 23 W,  
2000 lumens, 80+ CRI, 3000K

**Xm20/10c/30K/750**

Input Power: 11.2 W  
Lumens: 749 lm  
Efficacy: 67 lm/W  
CBCP: 11648  
Beam Angle: 10.6°  
Field Angle: 20.8°  
Spacing Criteria: 0.19

∠	0°	45°	90°
0°	11648	11648	11648
5°	6264	6089	5926
10°	1275	1202	1208
15°	502	487	477
20°	215	210	202
25°	97	96	93
30°	54	56	52
35°	35	34	31
40°	21	20	19
45°	10	9	10

**Xm20/15c/30K/2000**

Input Power: 22.7 W  
Lumens: 1978 lm  
Efficacy: 87 lm/W  
CBCP: 15892  
Beam Angle: 16.2°  
Field Angle: 33.7°  
Spacing Criteria: 0.28

∠	0°	45°	90°
0°	15871	15871	15871
5°	12935	12636	12231
10°	5971	5675	5433
15°	2207	2176	2116
20°	1027	977	936
25°	484	473	436
30°	246	252	230
35°	157	157	146
40°	122	115	109
45°	106	99	88

**Xm20/25c/30K/2000**

Input Power: 22.8 W  
Lumens: 1821 lm  
Efficacy: 80 lm/W  
CBCP: 6729  
Beam Angle: 23.3°  
Field Angle: 50.4°  
Spacing Criteria: 0.41

∠	0°	45°	90°
0°	6729	6729	6729
5°	5937	5855	5779
10°	4081	3975	3895
15°	2348	2291	2231
20°	1274	1228	1203
25°	710	683	676
30°	427	411	404
35°	280	270	265
40°	198	189	187
45°	135	124	124

**Xm20/40c/30K/2000**

Input Power: 22.4 W  
Lumens: 1823 lm  
Efficacy: 81 lm/W  
CBCP: 3312  
Beam Angle: 39.7°  
Field Angle: 72.4°  
Spacing Criteria: 0.72

∠	0°	45°	90°
0°	3310	3310	3310
5°	3180	3206	3216
10°	2795	2843	2868
15°	2227	2283	2320
20°	1591	1636	1682
25°	1021	1047	1095
30°	603	618	655
35°	347	355	378
40°	207	212	224
45°	131	133	140

**Xm20/60c/30K/2000**

Input Power: 22.9 W  
Lumens: 1990 lm  
Efficacy: 87 lm/W  
CBCP: 1121  
Beam Angle: 53.3°  
Field Angle: 91.4°  
Spacing Criteria: 1.00

∠	0°	45°	90°
0°	1118	1118	1118
5°	1089	1085	1076
10°	1030	1018	997
15°	937	922	887
20°	799	770	737
25°	632	598	576
30°	460	431	414
35°	308	287	279
40°	201	187	180
45°	126	117	108

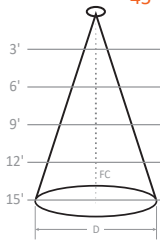

3'	0.56' D; 906 FC	0.85' D; 1234 FC	1.23' D; 523 FC	2.16' D; 257 FC	3.01' D; 87 FC
6'	1.11' D; 227 FC	1.70' D; 309 FC	2.47' D; 131 FC	2.47' D; 64 FC	6.02' D; 22 FC
9'	1.67' D; 101 FC	2.55' D; 137 FC	3.70' D; 58 FC	6.49' D; 29 FC	9.03' D; 10 FC
12'	2.23' D; 57 FC	3.41' D; 77 FC	4.94' D; 33 FC	8.65' D; 16 FC	12.04' D; 5 FC
15'	2.78' D; 36 FC	4.26' D; 49 FC	6.17' D; 21 FC	10.82' D; 10 FC	15.06' D; 4 FC

MULTI-OPTIC: Baseline for 16 W,  
1450 lumens, 80+ CRI, 3000K

**Xm20/15m/30K/1450**

Input Power: 16.2 W  
Lumens: 1595 lm  
Efficacy: 98 lm/W  
CBCP: 18848  
Beam Angle: 12.7°  
Field Angle: 28.0°  
Spacing Criteria: 0.22

∠	0°	45°	90°
0°	18848	18848	18848
5°	11986	12047	12378
10°	4597	4761	4865
15°	1318	1708	1443
20°	449	521	469
25°	227	262	235
30°	165	172	160
35°	102	112	106
40°	70	76	83
45°	37	34	36

**Xm20/25m/30K/1450**

Input Power: 16.1 W  
Lumens: 1525 lm  
Efficacy: 95 lm/W  
CBCP: 5928  
Beam Angle: 26.1°  
Field Angle: 49.2°  
Spacing Criteria: 0.46

∠	0°	45°	90°
0°	5928	5928	5928
5°	5307	5357	5371
10°	3847	3970	4026
15°	2233	2393	2486
20°	1081	1179	1266
25°	501	554	600
30°	247	278	298
35°	134	152	160
40°	82	89	91
45°	48	54	55

**Xm20/40m/30K/1450**

Input Power: 16.2 W  
Lumens: 1434 lm  
Efficacy: 89 lm/W  
CBCP: 2886  
Beam Angle: 38.2°  
Field Angle: 69.9°  
Spacing Criteria: 0.69

∠	0°	45°	90°
0°	2886	2886	2886
5°	2813	2786	2753
10°	2422	2405	2364
15°	1922	1923	1882
20°	1409	1408	1385
25°	902	915	905
30°	513	532	524
35°	282	292	291
40°	155	161	161
45°	83	84	84

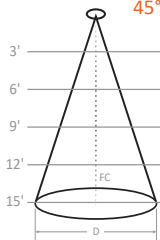

3'	0.67' D; 1466 FC	1.39' D; 461 FC	2.08' D; 225 FC
6'	1.33' D; 367 FC	2.78' D; 115 FC	4.16' D; 56 FC
9'	2' D; 163 FC	4.17' D; 51 FC	6.23' D; 25 FC
12'	2.66' D; 92 FC	5.56' D; 29 FC	8.31' D; 14 FC
15'	3.33' D; 59 FC	6.95' D; 18 FC	10.39' D; 9 FC

**CRI-CCT MULTIPLIER**

CRI	CCT	Multiplier
8 (80+)	2200K	0.86
	2500K	0.91
	2700K	0.96
	3000K	1.00
	3500K	1.03
9 (90+)	4000K	1.05
	2200K	0.70
	2500K	0.77
	2700K	0.83
M (MonoWhite)	3000K	0.86
	3500K	0.88
	V (VioLight)	3000K

**OUTPUT MULTIPLIER**

Package	Multiplier
17 W 1500 lm Xm20 COB-optic	0.82
13 W 1100 lm Xm20 COB-optic	0.77

## XR3nc

### X-SERIES | XM20 | 3-INCH ROUND RECESSED DOWNLIGHT

PROJECT \_\_\_\_\_

TYPE \_\_\_\_\_

SPECIFICATION \_\_\_\_\_

#### TM30 COLOR REPORTS

- 3000K with 80+ CRI
- $R_f = 84$ ;  $R_g = 94$
- $R_A = 82$ ;  $R_9 = 11$
- 3000K with 90+ CRI
- $R_f = 92$ ;  $R_g = 100$
- $R_A = 93$ ;  $R_9 = 56$
- 3000K with 97+ CRI
- $R_f = 96$ ;  $R_g = 104$
- $R_A = 97$ ;  $R_9 = 98$
- 3000K with MonoWhite
- $R_f = 91$ ;  $R_g = 100$
- $R_A = 91$ ;  $R_9 = 42$

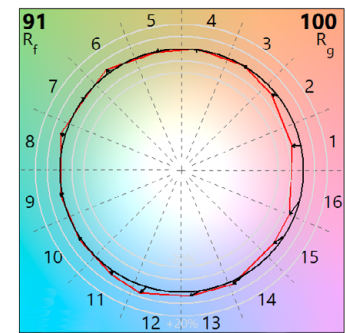
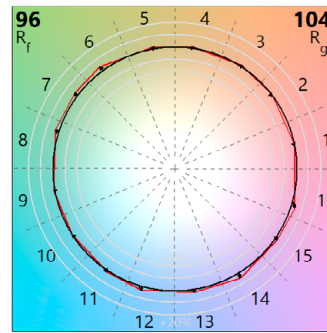
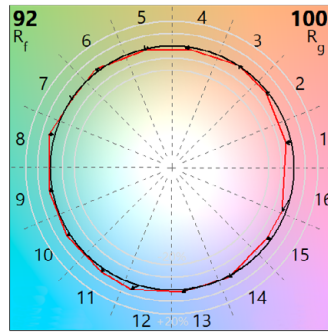
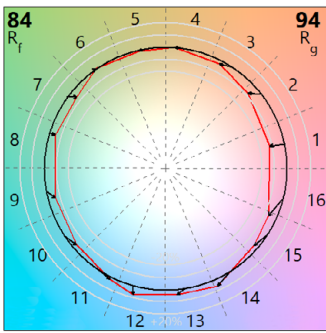
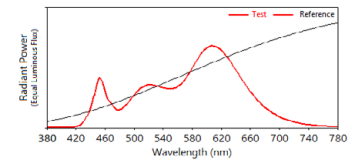
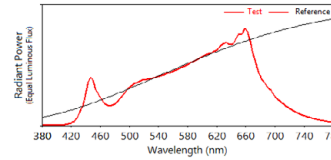
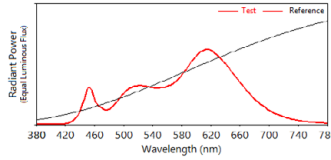
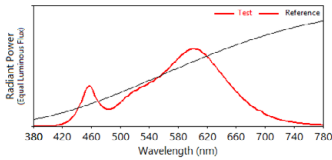

#### DIM TO WARM DETAILS | Dim to warm only available with 25° and 40° beam spreads; 90+CRI

- 2700K to 1800K with 90+ CRI
- $R_f = 92$ ;  $R_g = 100$
- $R_A = 93$ ;  $R_9 = 57$

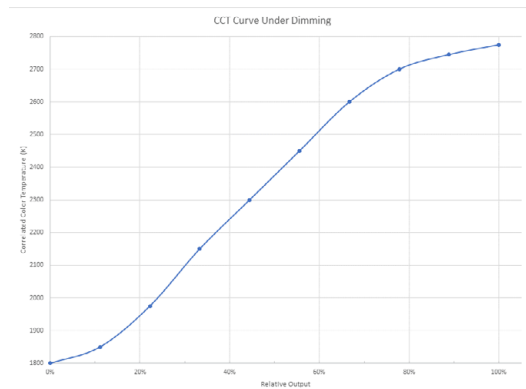
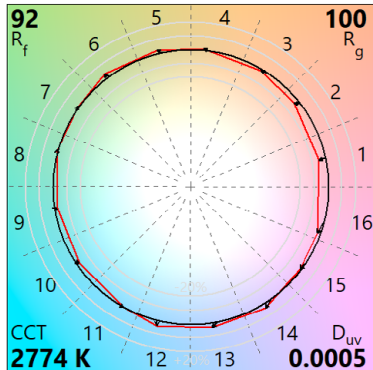
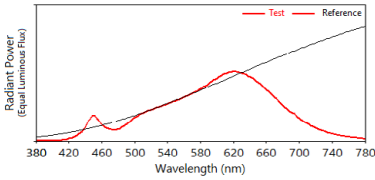

#### Xm20/25c/30K/1000

Input Power: 15.7 W  
Lumens: 1012 lm  
Efficacy: 65 lm/W  
CBCP: 3537  
Beam Angle: 28.0°  
Field Angle: 53.4°  
Spacing Criteria: 0.50

∠	0°	45°	90°
0°	3530	3530	3530
5°	3328	3305	3281
10°	2575	2546	2499
15°	1630	1619	1592
20°	894	890	874
25°	441	435	433
30°	222	216	217
35°	106	102	100
40°	43	40	40
45°	9	9	9

#### Xm20/40c/30K/1000

Input Power: 15.6 W  
Lumens: 967 lm  
Efficacy: 62 lm/W  
CBCP: 2231  
Beam Angle: 36.1°  
Field Angle: 65.0°  
Spacing Criteria: 0.65

∠	0°	45°	90°
0°	2225	2225	2225
5°	2148	2142	2128
10°	1880	1850	1824
15°	1434	1394	1366
20°	953	920	896
25°	563	540	527
30°	310	296	290
35°	157	152	149
40°	75	72	70
45°	31	30	29

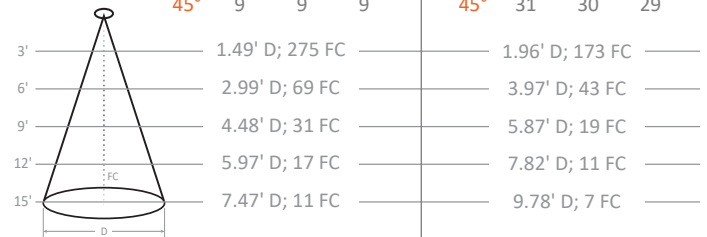

**WARNING:** Not for use in fully enclosed luminaires. Risk of electric shock. Use in an indoor, dry location only. This device is not intended for use with emergency exit fixtures or emergency exit lights. May not be compatible with all dimmers; please visit [solais.com/dimming](http://solais.com/dimming) for up-to-date dimmer compatibility information.

**NOTES:** This device complies with Part 15 of the FCC Rule. This product may cause interference with other devices. If interference occurs, change the locations of the products involved. **Compatible on 120v systems.**