

**XFR****X-SERIES | XM20  
FULLY RECESSED MULTIPLE**

PROJECT \_\_\_\_\_

TYPE \_\_\_\_\_

SPECIFICATION \_\_\_\_\_

- 120 V
- 0-10 V\*, Triac and ELV dimming
- 50,000 hours (L70)
- Integrated driver
- RoHS-compliant
- Contain no lead or mercury
- Certified to UL standards for dry locations
- Modular individually specifiable optics
- Modules are field-replaceable for easy maintenance and design changes; no tools needed
- Field- adjustable gimbal rings for hot aiming
- Designed for new construction ceilings only.
- Rated for IC and non-IC use; spray foam rated\* option available
- **ViOLight** and **\*MonoWhite** color rendering enhancements available
- \*90+ High CRI available  
To order, replace 'K' in CCT designation with 'h' in ordering code

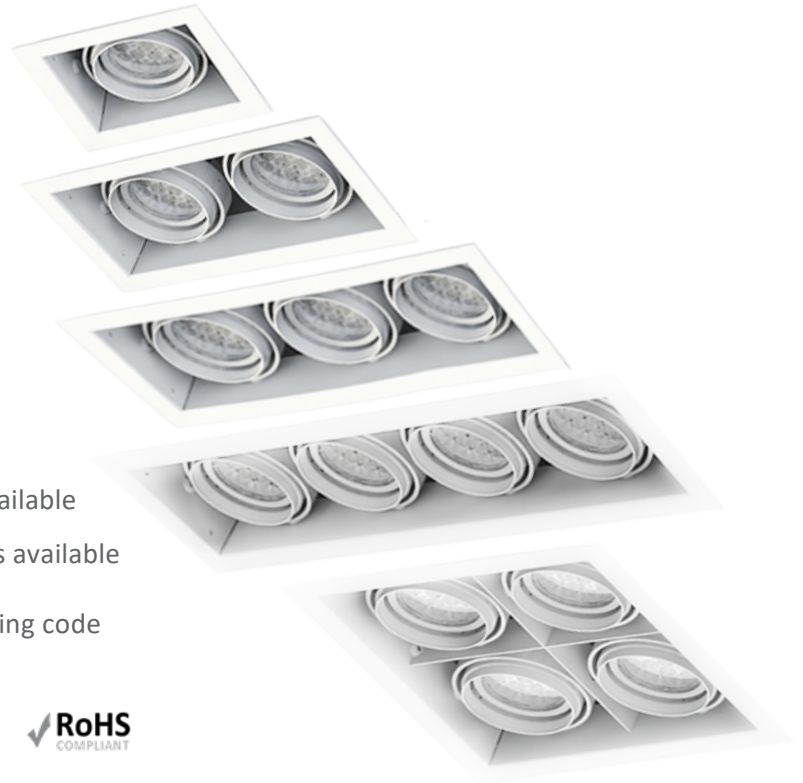

## XFR11

X-SERIES | XM20 | 1-HEAD  
FULLY RECESSED MULTIPLE

PROJECT \_\_\_\_\_

TYPE \_\_\_\_\_

SPECIFICATION \_\_\_\_\_

- Weight without module: 6.75 lb
- Ceiling Cut-Out: 6 1/4" x 5 1/8"

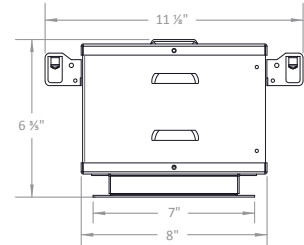
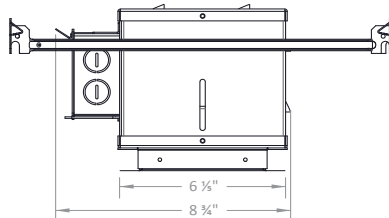

### Ordering Information

Example: XFR11/Xm20/25m-25m/30K/1100/WH/WH/SL-SL

Fixture	Module	Beam Spread	CCT / Lumens	Options + Accessories
XFR11	Xm20	COB-optic	25K* / 1000	Module Options
		15c	27K / 1050	SS - Solite Spread
		25c	30K / 1100	HL - Honeycomb Louver
		40c	30m* / 1100	SL - Linear Spread
		60c	35K* / 1100	SP - Prismatic Spread
			35m* / 1100	More Accessories Available
			40K* / 1100	Fixture Options
			25K* / 1300	SFR* - Spray Foam Rated
			27K / 1450	O10 - 0-10 V Dimming*
			30K / 1500	EM - Emergency Backup
			30m* / 1500	Microinverter*
			35K* / 1500	
			35m* / 1500	
			40K* / 1500	
			25K* / 1800	
			27K / 1900	
			30K / 2000	
			30m* / 2000	
			35K* / 2000	
			35m* / 2000	
			40K* / 2000	
		Multi-optic	27K / 1400	
		15m	30K / 1450	
		25m	30v / 1450	
		40m	35K* / 1450	
		60m	40K* / 1450	
		Specialty	27K / 750	
		10c	30K / 750	
		Dim-to-Warm	(2700K to 1800K)	
		25c	D27 / 1300	
		40c		

\*Consult factory for lead time and availability

# XFR12

X-SERIES | XM20 | 2-HEAD  
FULLY RECESSED MULTIPLE

PROJECT \_\_\_\_\_

TYPE \_\_\_\_\_

SPECIFICATION \_\_\_\_\_

- Weight without module: 7 lb
- Ceiling Cut-Out: 11" x 5 1/2"

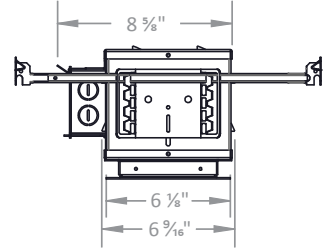
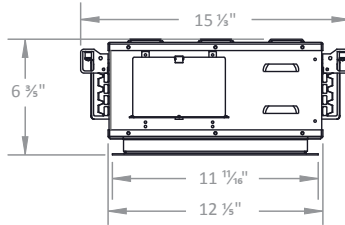

**Ordering Information** Example: XFR12/Xm20/25c-25c/30K/1100/WH/WH/SL-SL



Fixture	Module	Beam Spread	CCT / Lumens	Options + Accessories
XFR12	Xm20	COB-optic	25K* / 1000	<b>Module Options</b> SS - Solite Spread HL - Honeycomb Louver SL - Linear Spread SP - Prismatic Spread More Accessories Available  <b>Fixture Options</b> SFR* - Spray Foam Rated 010 - 0-10 V Dimming* EM - Emergency Backup Microinverter*
		15c	27K / 1050	
		25c	30K / 1100	
		40c	30m* / 1100	
		60c	35K* / 1100	
			35m* / 1100	
			40K* / 1100	
			25K* / 1300	
			27K / 1450	
			30K / 1500	
			30m* / 1500	
			35K* / 1500	
			35m* / 1500	
			40K* / 1500	
			25K* / 1800	
			27K / 1900	
			30K / 2000	
			30m* / 2000	
			35K* / 2000	
			35m* / 2000	
			40K* / 2000	
		Multi-optic	27K / 1400	
		15m	30K / 1450	
		25m	30v / 1450	
		40m	35K* / 1450	
		60m	40K* / 1450	
		Specialty	27K / 750	
		10c	30K / 750	
		Dim-to-Warm	(2700K to 1800K)	
		25c	D27 / 1300	
		40c		

**Finish**  
 Die-cast, Powder Coated  
 WH / WH - White Module, Interior + Flange  
 BK / BK - Black Module, Interior + Flange  
 BK / WH\* - Black Module + Interior, White Flange  
 PW / PW\* - Perfect White Module, Interior + Flange  
 BK / PW\* - Black Module + Interior, Perfect White Flange

\*Consult factory for lead time and availability

# XFR13

X-SERIES | XM20 | 3-HEAD  
FULLY RECESSED MULTIPLE

PROJECT \_\_\_\_\_

TYPE \_\_\_\_\_

SPECIFICATION \_\_\_\_\_

- Weight without module: 8 lb
- Ceiling Cut-Out: 16" x 5 1/2"

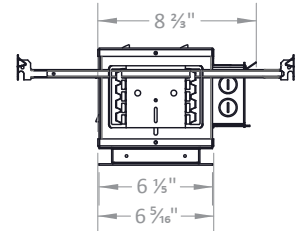
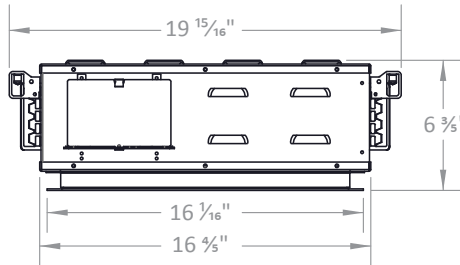

### Ordering Information

Example: XFR13/Xm20/25m-25m-25m/30K/1100/WH/WH/SL-SL-SL

1		2		3		1		2		3	
Fixture	Module	Beam Spread	CCT / Lumens	Options + Accessories							
XFR13	Xm20	COB-optic	25K* / 1000	<b>Options + Accessories</b> Module Options SS - Solite Spread HL - Honeycomb Louver SL - Linear Spread SP - Prismatic Spread More Accessories Available  Fixture Options SFR* - Spray Foam Rated 010 - 0-10 V Dimming* EM - Emergency Backup Microinverter*  <b>Finish</b> Die-cast, Powder Coated WH / WH - White Module, Interior + Flange BK / BK - Black Module, Interior + Flange BK / WH* - Black Module + Interior, White Flange PW / PW* - Perfect White Module, Interior + Flange BK / PW* - Black Module + Interior, Perfect White Flange							
		15c	27K / 1050								
		25c	30K / 1100								
		40c	30m* / 1100								
		60c	35K* / 1100								
			35m* / 1100								
			40K* / 1100								
			25K* / 1300								
			27K / 1450								
			30K / 1500								
			30m* / 1500								
			35K* / 1500								
			35m* / 1500								
			40K* / 1500								
			25K* / 1800								
			27K / 1900								
			30K / 2000								
			30m* / 2000								
			35K* / 2000								
			35m* / 2000								
			40K* / 2000								
		Multi-optic	27K / 1400								
		15m	30K / 1450								
		25m	30v / 1450								
		40m	35K* / 1450								
		60m	40K* / 1450								
		Specialty	27K / 750								
		10c	30K / 750								
		Dim-to-Warm	(2700K to 1800K)								
		25c	D27 / 1300								
		40c									

\*Consult factory for lead time and availability



# XFR22

## X-SERIES | XM20 | 4-HEAD FULLY RECESSED MULTIPLE

PROJECT \_\_\_\_\_

TYPE \_\_\_\_\_

SPECIFICATION \_\_\_\_\_

- Weight without module: 10.8 lb
- Ceiling Cut-Out: 11" x 11"

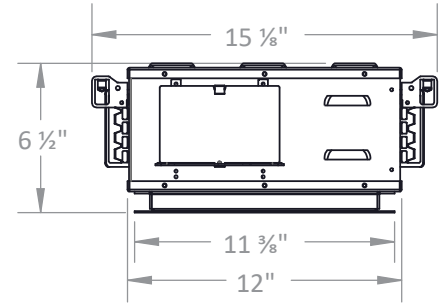
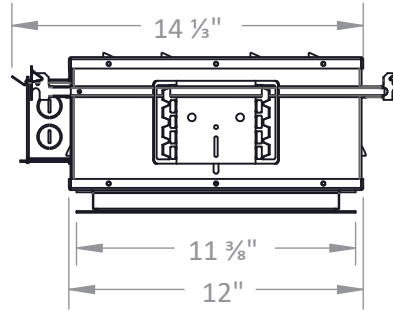

### Ordering Information

Example: XFR22/Xm20/25c-25c-25c-25c/30K/1100/WH/WH/SL-SL-SL-SL

1 - 2 - 3 - 4

1 - 2 - 3 - 4



Fixture	Module	Beam Spread	CCT / Lumens	Options + Accessories
XFR22	Xm20	COB-optic	25K* / 1000	Module Options
		15c	27K / 1050	TS - Tapered Snoot
		25c	30K / 1100	HL - Honeycomb Louver
		40c	30m* / 1100	SL - Linear Spread
		60c	35K* / 1100	SP - Prismatic Spread
			35m* / 1100	More Accessories Available
			40K* / 1100	Fixture Options
			25K* / 1300	SFR* - Spray Foam Rated
			27K / 1450	O10 - 0-10 V Dimming*
			30K / 1500	EM - Emergency Backup
			30m* / 1500	Microinverter*
			35K* / 1500	
			35m* / 1500	
			40K* / 1500	
			25K* / 1800	
			27K / 1900	
			30K / 2000	
			30m* / 2000	
			35K* / 2000	
			35m* / 2000	
			40K* / 2000	
		Multi-optic	27K / 1400	
		15m	30K / 1450	
		25m	30v / 1450	
		40m	35K* / 1450	
		60m	40K* / 1450	
		Specialty	27K / 750	
		10c	30K / 750	
		Dim-to-Warm	(2700K to 1800K)	
		25c	D27 / 1300	
		40c		

\*Consult factory for lead time and availability

XFR

X-SERIES | XM20  
FULLY RECESSED MULTIPLE

PROJECT \_\_\_\_\_

TYPE \_\_\_\_\_

SPECIFICATION \_\_\_\_\_

PHOTOMETRIC DETAILS | baseline X output multiplier X cri-cct multiplier = final output

COB OPTIC: Baseline for 23 W,  
2000 lumens, 80+ CRI, 3000K

**Xm20/10c/30K/750**

Input Power: 11.2 W  
Lumens: 749 lm  
Efficacy: 67 lm/W  
CBCP: 11648  
Beam Angle: 10.6°  
Field Angle: 20.8°  
Spacing Criteria: 0.19

∠	0°	45°	90°
0°	11648	11648	11648
5°	6264	6089	5926
10°	1275	1202	1208
15°	502	487	477
20°	215	210	202
25°	97	96	93
30°	54	56	52
35°	35	34	31
40°	21	20	19
45°	10	9	10

**Xm20/15c/30K/2000**

Input Power: 22.7 W  
Lumens: 1978 lm  
Efficacy: 87 lm/W  
CBCP: 15892  
Beam Angle: 16.2°  
Field Angle: 33.7°  
Spacing Criteria: 0.28

∠	0°	45°	90°
0°	15871	15871	15871
5°	12935	12636	12231
10°	5971	5675	5433
15°	2207	2176	2116
20°	1027	977	936
25°	484	473	436
30°	246	252	230
35°	157	157	146
40°	122	115	109
45°	106	99	88

**Xm20/25c/30K/2000**

Input Power: 22.8 W  
Lumens: 1821 lm  
Efficacy: 80 lm/W  
CBCP: 6729  
Beam Angle: 23.3°  
Field Angle: 50.4°  
Spacing Criteria: 0.41

∠	0°	45°	90°
0°	6729	6729	6729
5°	5937	5855	5779
10°	4081	3975	3895
15°	2348	2291	2231
20°	1274	1228	1203
25°	710	683	676
30°	427	411	404
35°	280	270	265
40°	198	189	187
45°	135	124	124

**Xm20/40c/30K/2000**

Input Power: 22.4 W  
Lumens: 1823 lm  
Efficacy: 81 lm/W  
CBCP: 3312  
Beam Angle: 39.7°  
Field Angle: 72.4°  
Spacing Criteria: 0.72

∠	0°	45°	90°
0°	3310	3310	3310
5°	3180	3206	3216
10°	2795	2843	2868
15°	2227	2283	2320
20°	1591	1636	1682
25°	1021	1047	1095
30°	603	618	655
35°	347	355	378
40°	207	212	224
45°	131	133	140

**Xm20/60c/30K/2000**

Input Power: 22.9 W  
Lumens: 1990 lm  
Efficacy: 87 lm/W  
CBCP: 1121  
Beam Angle: 53.3°  
Field Angle: 91.4°  
Spacing Criteria: 1.00

∠	0°	45°	90°
0°	1118	1118	1118
5°	1089	1085	1076
10°	1030	1018	997
15°	937	922	887
20°	799	770	737
25°	632	598	576
30°	460	431	414
35°	308	287	279
40°	201	187	180
45°	126	117	108

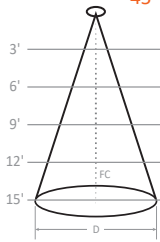

3'	0.56' D; 906 FC	0.85' D; 1234 FC	1.23' D; 523 FC	2.16' D; 257 FC	3.01' D; 87 FC
6'	1.11' D; 227 FC	1.70' D; 309 FC	2.47' D; 131 FC	2.47' D; 64 FC	6.02' D; 22 FC
9'	1.67' D; 101 FC	2.55' D; 137 FC	3.70' D; 58 FC	6.49' D; 29 FC	9.03' D; 10 FC
12'	2.23' D; 57 FC	3.41' D; 77 FC	4.94' D; 33 FC	8.65' D; 16 FC	12.04' D; 5 FC
15'	2.78' D; 36 FC	4.26' D; 49 FC	6.17' D; 21 FC	10.82' D; 10 FC	15.06' D; 4 FC

MULTI-OPTIC: Baseline for 16 W,  
1450 lumens, 80+ CRI, 3000K

**Xm20/15m/30K/1450**

Input Power: 16.2 W  
Lumens: 1595 lm  
Efficacy: 98 lm/W  
CBCP: 18848  
Beam Angle: 12.7°  
Field Angle: 28.0°  
Spacing Criteria: 0.22

∠	0°	45°	90°
0°	18848	18848	18848
5°	11986	12047	12378
10°	4597	4761	4865
15°	1318	1708	1443
20°	449	521	469
25°	227	262	235
30°	165	172	160
35°	102	112	106
40°	70	76	83
45°	37	34	36

**Xm20/25m/30K/1450**

Input Power: 16.1 W  
Lumens: 1525 lm  
Efficacy: 95 lm/W  
CBCP: 5928  
Beam Angle: 26.1°  
Field Angle: 49.2°  
Spacing Criteria: 0.46

∠	0°	45°	90°
0°	5928	5928	5928
5°	5307	5357	5371
10°	3847	3970	4026
15°	2233	2393	2486
20°	1081	1179	1266
25°	501	554	600
30°	247	278	298
35°	134	152	160
40°	82	89	91
45°	48	54	55

**Xm20/40m/30K/1450**

Input Power: 16.2 W  
Lumens: 1434 lm  
Efficacy: 89 lm/W  
CBCP: 2886  
Beam Angle: 38.2°  
Field Angle: 69.9°  
Spacing Criteria: 0.69

∠	0°	45°	90°
0°	2886	2886	2886
5°	2813	2786	2753
10°	2422	2405	2364
15°	1922	1923	1882
20°	1409	1408	1385
25°	902	915	905
30°	513	532	524
35°	282	292	291
40°	155	161	161
45°	83	84	84

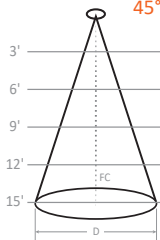

3'	0.67' D; 1466 FC	1.39' D; 461 FC	2.08' D; 225 FC
6'	1.33' D; 367 FC	2.78' D; 115 FC	4.16' D; 56 FC
9'	2' D; 163 FC	4.17' D; 51 FC	6.23' D; 25 FC
12'	2.66' D; 92 FC	5.56' D; 29 FC	8.31' D; 14 FC
15'	3.33' D; 59 FC	6.95' D; 18 FC	10.39' D; 9 FC

CRI-CCT MULTIPLIER

CRI	CCT	Multiplier
8 (80+)	2200K	0.86
	2500K	0.91
	2700K	0.96
	3000K	1.00
	3500K	1.03
9 (90+)	4000K	1.05
	2200K	0.70
	2500K	0.77
	2700K	0.83
M (MonoWhite)	3000K	0.86
	3500K	0.88
	V (VioLight)	3000K

OUTPUT MULTIPLIER

Package	Multiplier
17 W 1500 lm Xm20 COB-optic	0.82
13 W 1100 lm Xm20 COB-optic	0.77

# XFR

## X-SERIES | XM20 SEMI RECESSED MULTIPLE

PROJECT \_\_\_\_\_

TYPE \_\_\_\_\_

SPECIFICATION \_\_\_\_\_

### TM30 COLOR REPORTS

- 3000K with 80+ CRI
- $R_f = 84$ ;  $R_g = 94$
- $R_A = 82$ ;  $R_9 = 11$

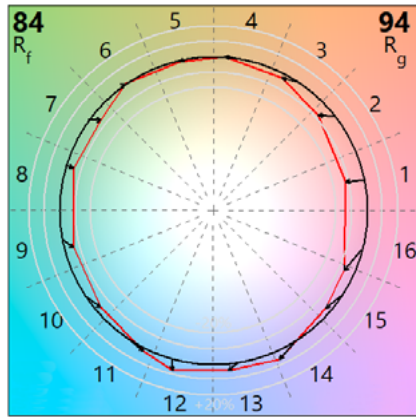
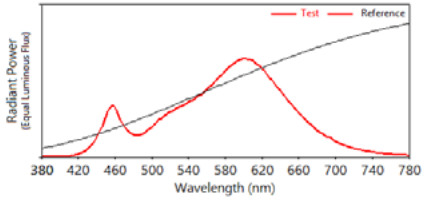

- 3000K with 90+ CRI
- $R_f = 92$ ;  $R_g = 100$
- $R_A = 93$ ;  $R_9 = 56$

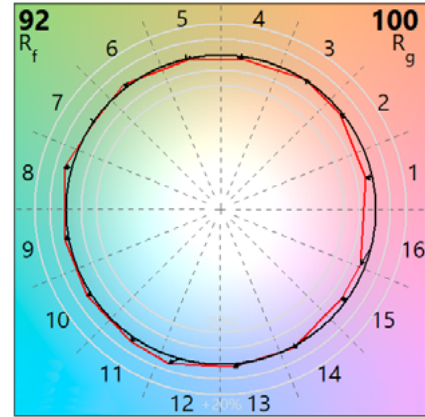
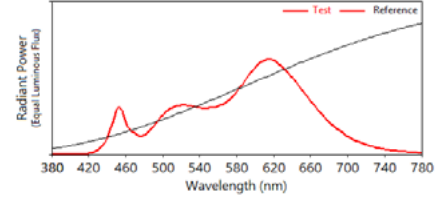

- 3000K with 97+ CRI
- $R_f = 96$ ;  $R_g = 104$
- $R_A = 97$ ;  $R_9 = 98$

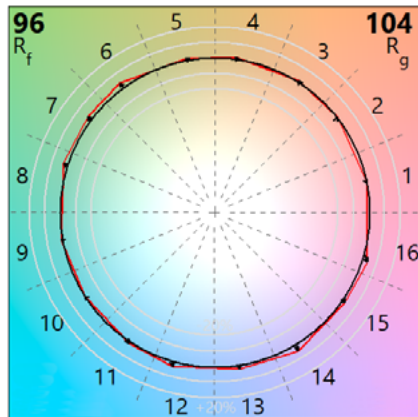
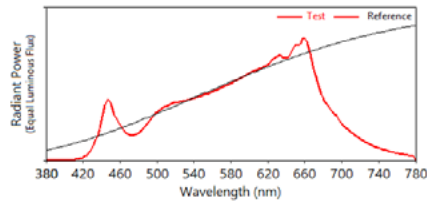

- 3000K with MonoWhite
- $R_f = 91$ ;  $R_g = 100$
- $R_A = 91$ ;  $R_9 = 42$

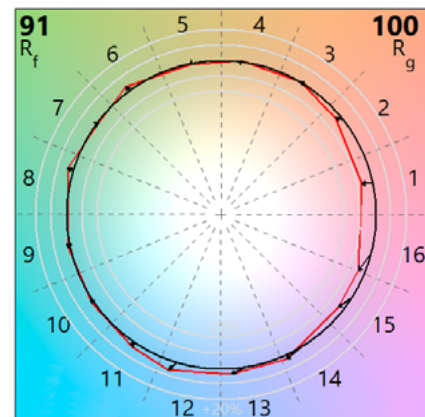
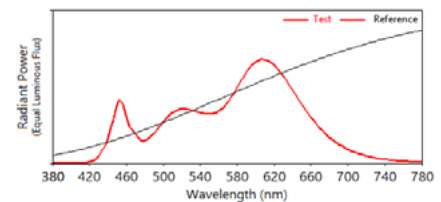

# XFR

## X-SERIES | XM20 SEMI RECESSED MULTIPLE

PROJECT \_\_\_\_\_

TYPE \_\_\_\_\_

SPECIFICATION \_\_\_\_\_

### DIM TO WARM DETAILS | Dim to warm only available with 25° and 40° beam spreads; 90+ CRI

- 2700K to 1800K with 90+ CRI
- $R_f = 92$ ;  $R_g = 100$
- $R_A = 93$ ;  $R_g = 57$

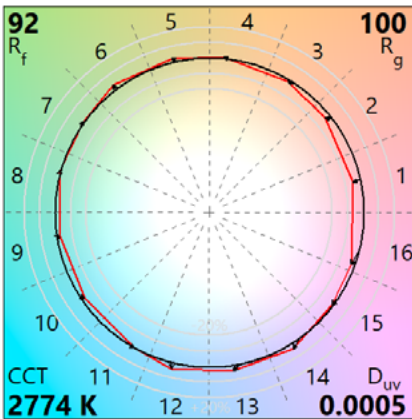
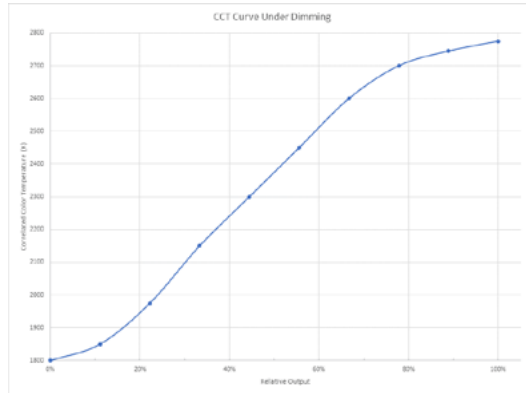
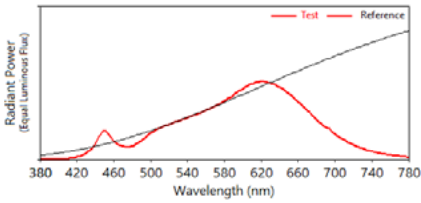

#### Xm20/25c/D27/1300

Input Power: 18.3 W  
Lumens: 1277 lm  
Efficacy: 70 lm/W  
CBCP: 4427  
Beam Angle: 27.9°  
Field Angle: 53.1°  
Spacing Criteria: 0.50

∠	0°	45°	90°
0°	4410	4410	4410
5°	4262	4250	4150
10°	3388	3404	3243
15°	2218	2252	2097
20°	1234	1269	1166
25°	609	624	577
30°	312	314	289
35°	152	151	141
40°	66	69	65
45°	24	26	25

#### Xm20/40c/D27/1300

Input Power: 18.3 W  
Lumens: 1247 lm  
Efficacy: 68 lm/W  
CBCP: 2806  
Beam Angle: 36.1°  
Field Angle: 65.9°  
Spacing Criteria: 0.50

∠	0°	45°	90°
0°	2796	2796	2796
5°	2742	2744	2713
10°	2432	2448	2398
15°	1867	1906	1849
20°	1247	1298	1252
25°	749	787	758
30°	423	443	426
35°	231	241	231
40°	116	122	118
45°	56	59	57

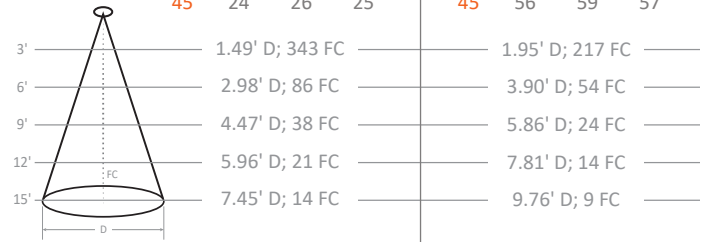

**WARNING:** Not for use in fully enclosed luminaires. Risk of electric shock. Use in an indoor, dry location only. This device is not intended for use with emergency exit fixtures or emergency exit lights. May not be compatible with all dimmers; please visit [solais.com/dimming](http://solais.com/dimming) for up-to-date dimmer compatibility information.  
**NOTES:** This device complies with Part 15 of the FCC Rule. This product may cause interference with other devices. If interference occurs, change the locations of the products involved. **Compatible on 120v systems.**



Luxiance utilizes active cooling to remove heat from the LED system - allowing Solais LED lamps to operate cooler, resulting in superior life, light output, and performance.



Thermal Throttle – In the event that Solais products begin to overheat, they will undetectably dim themselves to protect your technology investments.