

XPD

X-SERIES | XM24

3-STEP PULL-DOWN MULTIPLES

SOLAIS®

PROJECT _____

TYPE _____

SPECIFICATION _____

- 120 V
- 0-10 V*, Triac and ELV dimming
- Integrated driver
- Actively cooled fixtures
- 3 self-locking aiming height positions
- 0-90° vertical tilt; 360° rotation
- Modular individually specifiable optics
- 50,000 hours (L70)
- RoHS-compliant
- Dry location rating
- Certified to UL standards for dry locations
- Rated for IC and non-IC use
- Designed for new construction ceilings only
- **VioLight** and ***MonoWhite** color rendering enhancements available
- ***90+** High CRI available.
To order, replace 'K' in CCT designation with 'h' in ordering code.
- Aiming

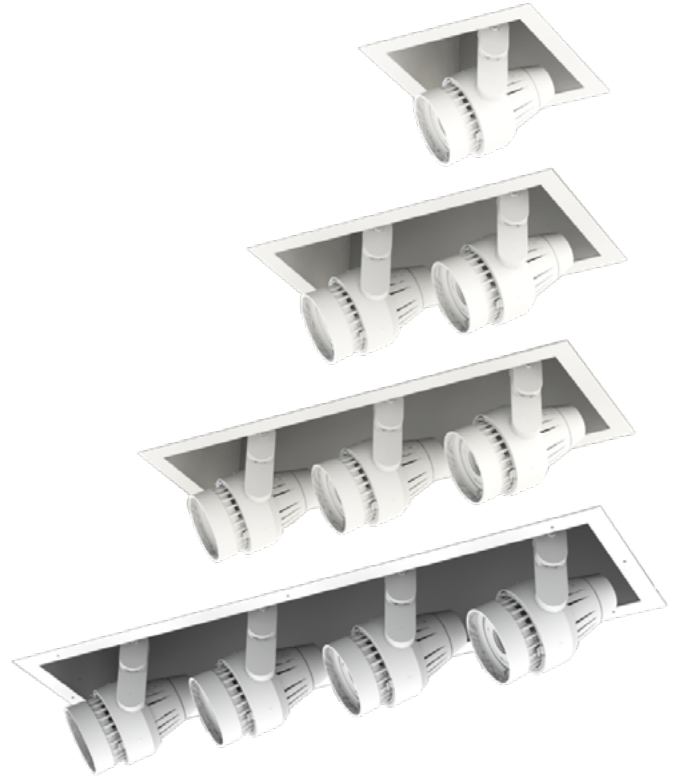

Position 1

Position 2

Position 3

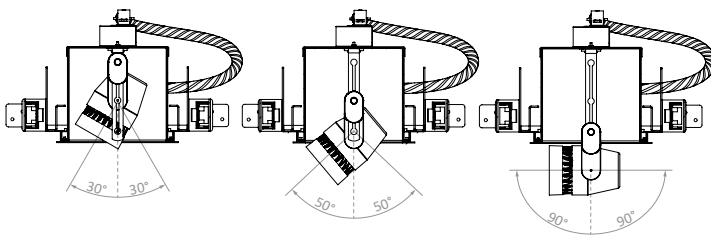

*Consult factory for lead time and availability

XPD11

X-SERIES | XM24 | 1-HEAD 3-STEP PULL-DOWN MULTIPLES

PROJECT _____

TYPE _____

SPECIFICATION _____

- Modular Fixture Weight (without modules): 7.5 lb
- Ceiling Cut-Out: 7 ¼" x 7 ¼"

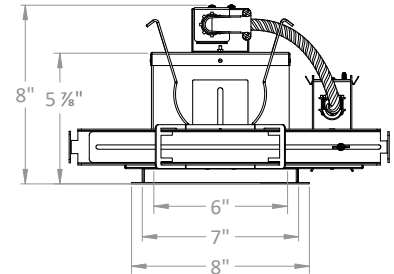
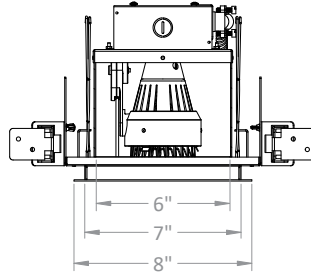
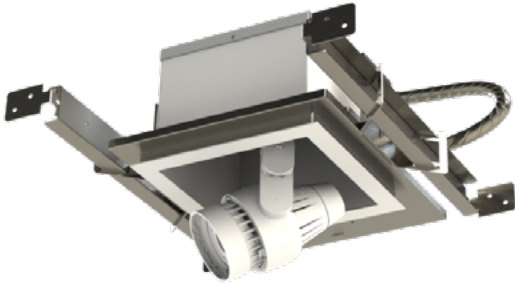

Ordering Information

Example: XPD11/Xm24/25/30K/2400/WH/WH/SL

Fixture	Module	Beam Spread	CCT / Lumens	Options + Accessories
XPD11	Xm24	COB-optic	25K* / 1400	Options + Accessories Module Options TS - Tapered Snoot HL - Honeycomb Louver SL - Linear Spread SP - Prismatic Spread More Accessories Available Fixture Options 010 - 0-10 V Dimming* EM - Emergency Backup Microinverter*
		15c	27K / 1550	
		25c	30K / 1600	
		40c	30m* / 1600	
		60c	35K* / 1600	
			35m* / 1600	
			40K* / 1600	
			25K* / 2000	
			27K / 2000	
			30K / 2000	
			30m* / 2000	
			35K* / 2000	
			35m* / 2000	
			40K* / 2000	
		Multi-optic	30v / 1850	
		15	27K / 2300	
		25	30K / 2400	
		40	35K* / 2400	
		60	40K* / 2400	
			27K / 3000	
			30K / 3000	
			35K* / 3000	
			40K* / 3000	

Finish

Die-cast, Powder Coated
 WH / WH - White Module, Interior + Flange
 BK / BK - Black Module, Interior + Flange
 BK / WH* - Black Module + Interior, White Flange
 PW / PW* - Perfect White Module, Interior + Flange
 BK / PW* - Black Module + Interior, Perfect White Flange

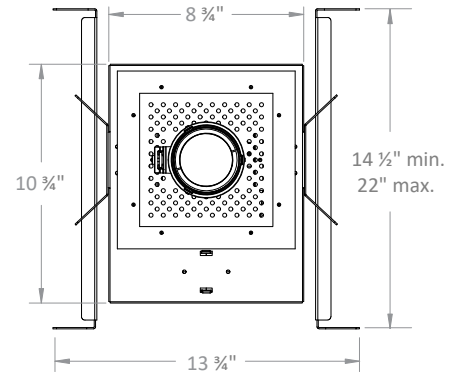

*Consult factory for lead time and availability

XPD12

X-SERIES | XM24 | 2-HEAD 3-STEP PULL-DOWN MULTIPLES

PROJECT _____

TYPE _____

SPECIFICATION _____

- Modular Fixture Weight (without modules): 11.25 lb
- Ceiling Cut-Out: 7 7/8" x 13 1/4"

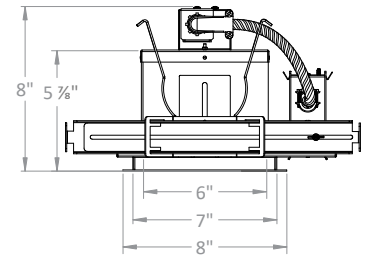
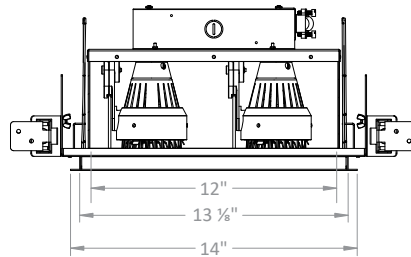
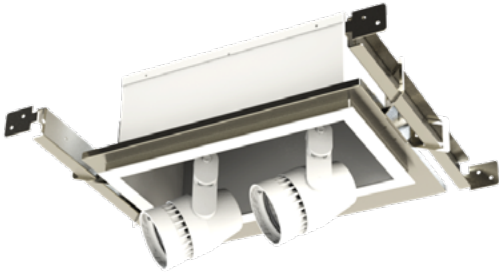

Ordering Information

Example: XPD12/Xm24/25-25/30K/2400/WH/WH/SL-SL

		1 - 2				1 - 2	
Fixture	Module	Beam Spread	CCT / Lumens	Options + Accessories			
XPD12	Xm24	COB-optic	25K* / 1400	Options + Accessories Module Options TS - Tapered Snoot HL - Honeycomb Louver SL - Linear Spread SP - Prismatic Spread More Accessories Available Fixture Options 010 - 0-10 V Dimming* EM - Emergency Backup Microinverter*			
		15c	27K / 1550				
		25c	30K / 1600				
		40c	30m* / 1600				
		60c	35K* / 1600				
			35m* / 1600				
			40K* / 1600				
			25K* / 2000				
			27K / 2000				
			30K / 2000				
			30m* / 2000				
			35K* / 2000				
			35m* / 2000				
			40K* / 2000				
		Multi-optic	30v / 1850				
		15	27K / 2300				
		25	30K / 2400				
		40	35K* / 2400				
		60	40K* / 2400				
			27K / 3000				
			30K / 3000				
			35K* / 3000				
			40K* / 3000				

Finish

- Die-cast, Powder Coated
- WH / WH - White Module, Interior + Flange
- BK / BK - Black Module, Interior + Flange
- BK / WH* - Black Module + Interior, White Flange
- PW / PW* - Perfect White Module, Interior + Flange
- BK / PW* - Black Module + Interior, Perfect White Flange

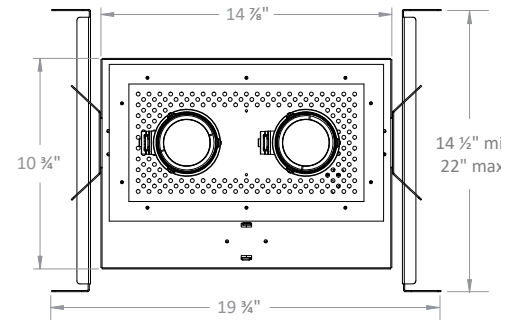

*Consult factory for lead time and availability

XPD13

X-SERIES | XM24 | 3-HEAD 3-STEP PULL-DOWN MULTIPLES

PROJECT _____

TYPE _____

SPECIFICATION _____

- Modular Fixture Weight (without modules): 14 lb
- Ceiling Cut-Out: 7 1/4" x 19 1/4"

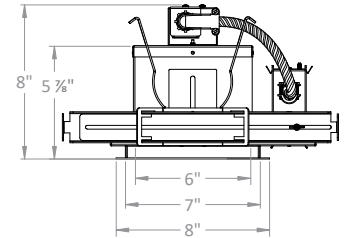
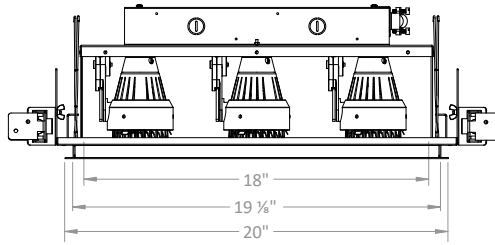
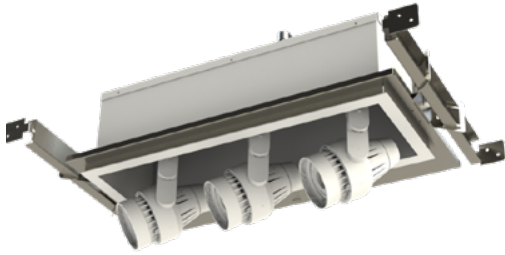

Ordering Information

Example: XPD13/Xm24/25-25-25/30K/2400/WH/WH/SL-SL-SL

		1 - 2 - 3		1 - 2 - 3	
Fixture	Module	Beam Spread	CCT / Lumens	Options + Accessories	
XPD13	Xm24	COB-optic	25K* / 1400	Module Options TS - Tapered Snoot HL - Honeycomb Louver SL - Linear Spread SP - Prismatic Spread More Accessories Available Fixture Options 010 - 0-10 V Dimming* EM - Emergency Backup Microinverter*	
		15c	27K / 1550		
		25c	30K / 1600		
		40c	30m* / 1600		
		60c	35K* / 1600		
			35m* / 1600		
			40K* / 1600		
			25K* / 2000		
			27K / 2000		
			30K / 2000		
			30m* / 2000		
			35K* / 2000		
			35m* / 2000		
			40K* / 2000		
		Multi-optic	30v / 1850	Finish Die-cast, Powder Coated WH / WH - White Module, Interior + Flange BK / BK - Black Module, Interior + Flange BK / WH* - Black Module + Interior, White Flange PW / PW* - Perfect White Module, Interior + Flange BK / PW* - Black Module + Interior, Perfect White Flange	
		15	27K / 2300		
		25	30K / 2400		
		40	35K* / 2400		
		60	40K* / 2400		
			27K / 3000		
			30K / 3000		
			35K* / 3000		
			40K* / 3000		

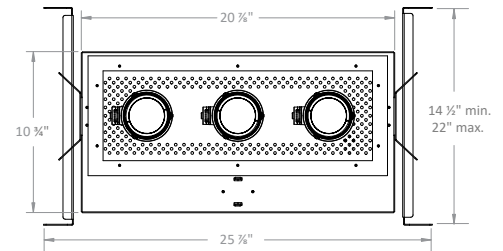

*Consult factory for lead time and availability

XPD14

X-SERIES | XM24 | 4-HEAD 3-STEP PULL-DOWN MULTIPLES

PROJECT _____

TYPE _____

SPECIFICATION _____

- Modular Fixture Weight (without modules): 15.5 lb
- Ceiling Cut-Out: 7 ¼" x 23 ⅜"

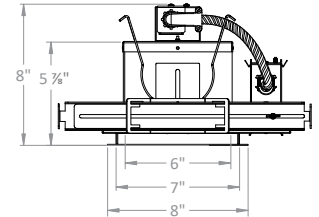
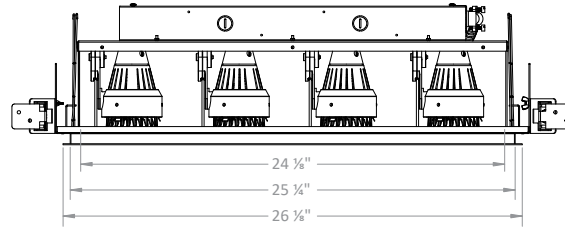
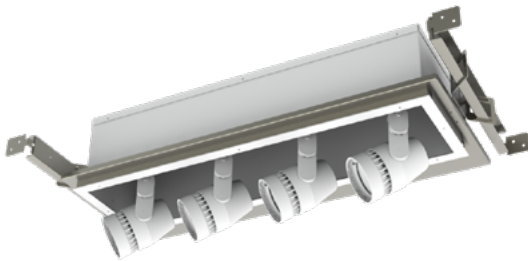

Ordering Information

Example: XPD14/Xm24/25-25-25-25/30K/2400/WH/WH/SL-SL-SL

		1 - 2 - 3 - 4				1 - 2 - 3 - 4				
Fixture	Module	Beam Spread	CCT / Lumens		Options + Accessories					
XPD14	Xm24	COB-optic	25K*	1400	Module Options					
		15c	27K	1550	TS - Tapered Snoot					
		25c	30K	1600	HL - Honeycomb Louver					
		40c	30m*	1600	SL - Linear Spread					
		60c	35K*	1600	SP - Prismatic Spread					
			35m*	1600	More Accessories Available					
			40K*	1600	Fixture Options					
			25K*	2000	010 - 0-10 V Dimming*					
			27K	2000	EM - Emergency Backup					
			30K	2000	Microinverter*					
			30m*	2000						
			35K*	2000						
			35m*	2000						
			40K*	2000						
		Multi-optic	30v	1850						
		15	27K	2300						
		25	30K	2400						
		40	35K*	2400						
		60	40K*	2400						
			27K	3000						
			30K	3000						
			35K*	3000						
			40K*	3000						

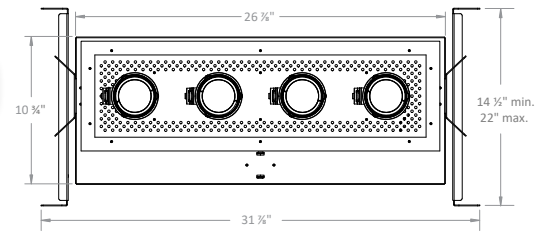

- Finish**
- Die-cast, Powder Coated
 - WH / WH - White Module, Interior + Flange
 - BK / BK - Black Module, Interior + Flange
 - BK / WH* - Black Module + Interior, White Flange
 - PW / PW* - Perfect White Module, Interior + Flange
 - BK / PW* - Black Module + Interior, Perfect White Flange

*Consult factory for lead time and availability

XPD

X-SERIES | XM24

3-STEP PULL-DOWN MULTIPLES

PROJECT _____

TYPE _____

SPECIFICATION _____

PHOTOMETRIC DETAILS | baseline X output multiplier X cri-cct multiplier = final output

COB OPTIC: Baseline data for 22 W, 2000 lumens, 80+ CRI, 3000K

Xm24/15c/30K/2000

Input Power:	22.5 W
Lumens:	1868 lm
Efficacy:	82.9 lm/W
Beam Angle:	19.2°
Field Angle:	49.1°

∠	0°	45°	90°
0°	7831	7831	7831
5°	6438	6425	6339
10°	3671	3628	3524
15°	1830	1823	1789
20°	1088	1090	1069
25°	726	736	709
30°	501	516	496
35°	342	353	344
40°	233	238	236
45°	157	160	163

Xm24/25c/30K/2000

Input Power:	21.9 W
Lumens:	2200 lm
Efficacy:	100.3 lm/W
Beam Angle:	23.9°
Field Angle:	59.8°

∠	0°	45°	90°
0°	6529	6529	6529
5°	5797	5759	5621
10°	4014	3962	3803
15°	2347	2286	2202
20°	1369	1344	1311
25°	904	894	874
30°	646	642	628
35°	458	465	453
40°	332	341	331
45°	241	250	242

Xm24/40c/30K/2000

Input Power:	22.2 W
Lumens:	2013 lm
Efficacy:	90.9 lm/W
Beam Angle:	38.8°
Field Angle:	85.9°

∠	0°	45°	90°
0°	3023	3023	3023
5°	2893	2871	2848
10°	2530	2476	2437
15°	2026	1961	1911
20°	1511	1447	1402
25°	1073	1023	987
30°	749	716	690
35°	527	507	491
40°	380	368	357
45°	278	271	263

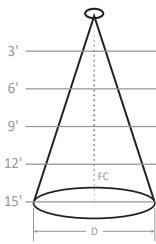

3'	1.01' D; 609 FC	1.27' D; 508 FC	2.11' D; 235 FC
6'	2.03' D; 152 FC	2.53' D; 127 FC	4.23' D; 59 FC
9'	3.04' D; 68 FC	3.80' D; 56 FC	6.34' D; 26 FC
12'	4.06' D; 38 FC	5.07' D; 32 FC	8.45' D; 15 FC
15'	5.07' D; 24 FC	6.34' D; 20 FC	10.56' D; 9 FC

OUTPUT MULTIPLIER

Package	Optic	Multiplier
18 W 1600 lm Xm24 COB	15°	0.80
	25°	0.80
	40°	0.79

CRI-CCT MULTIPLIER

CRI	CCT	Multiplier
8 (80+)	2200K	0.86
	2500K	0.91
	2700K	0.96
	3000K	1.00
	3500K	1.03
	4000K	1.05
9 (90+)	2200K	0.70
	2500K	0.77
	2700K	0.83
	3000K	0.86
	3500K	0.89
M (MonoWhite)	3000K	0.86
	3500K	0.88
V (VioLight)	3000K	0.89

MULTI-OPTIC: Baseline data for 26 W, 2400 lumens, 80+ CRI, 3000K

Xm24/15/30K/2400

Input Power:	26.4 W
Lumens:	2636 lm
Efficacy:	100.0 lm/W
Beam Angle:	14.8°
Field Angle:	26.1°

∠	0°	45°	90°
0°	32012	32012	32012
5°	23079	22740	22414
10°	7807	8170	8147
15°	1905	1732	1527
20°	642	512	463
25°	268	253	255
30°	157	151	150
35°	99	91	89
40°	72	66	62
45°	55	52	51

Xm24/25/30K/2400

Input Power:	26.4 W
Lumens:	2573 lm
Efficacy:	97.4 lm/W
Beam Angle:	27.2°
Field Angle:	48.4°

∠	0°	45°	90°
0°	9977	9977	9977
5°	9134	9161	9195
10°	6880	6928	6963
15°	4125	4130	4112
20°	1967	1951	1931
25°	824	797	783
30°	367	340	323
35°	191	172	164
40°	111	103	99
45°	69	68	67

Xm24/40/30K/2400

Input Power:	26.4 W
Lumens:	2385 lm
Efficacy:	90.5 lm/W
Beam Angle:	44.0°
Field Angle:	71.7°

∠	0°	45°	90°
0°	4057	4057	4057
5°	4083	3943	3829
10°	3913	3706	3506
15°	3452	3328	3021
20°	2599	2596	2302
25°	1651	1710	1532
30°	913	969	889
35°	456	488	459
40°	221	238	225
45°	112	112	103

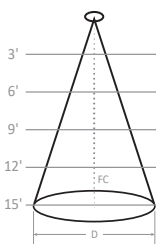

3'	0.78' D; 2490 FC	1.45' D; 776 FC	2.42' D; 316 FC
6'	1.56' D; 623 FC	2.90' D; 194 FC	4.84' D; 79 FC
9'	2.34' D; 277 FC	4.35' D; 86 FC	7.26' D; 35 FC
12'	3.12' D; 156 FC	5.81' D; 49 FC	9.68' D; 20 FC
15'	3.90' D; 100 FC	7.26' D; 31 FC	12.11' D; 13 FC

OUTPUT MULTIPLIER

Package	Optic	Multiplier
20 W 1850 lm Xm24 Multi-optic	15°	0.70
	25°	0.72
	40°	0.78

Package	Optic	Multiplier
28 W 3000 lm Xm24 Multi-optic	15°	1.13
	25°	1.17
	40°	1.12

XPD

X-SERIES | XM24 3-STEP PULL-DOWN MULTIPLES

TM30 COLOR REPORTS

- 3000K with 80+ CRI
- $R_f = 84$; $R_g = 94$
- $R_A = 82$; $R_g = 11$

- 3000K with 90+ CRI
- $R_f = 92$; $R_g = 100$
- $R_A = 93$; $R_g = 56$

- 3000K with 97+ CRI
- $R_f = 96$; $R_g = 104$
- $R_A = 97$; $R_g = 98$

- 3000K with MonoWhite
- $R_f = 91$; $R_g = 100$
- $R_A = 91$; $R_g = 42$

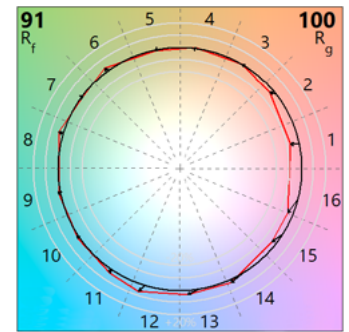
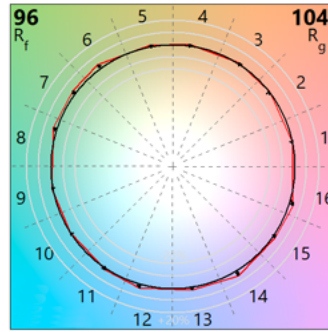
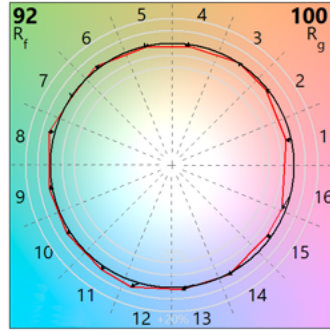
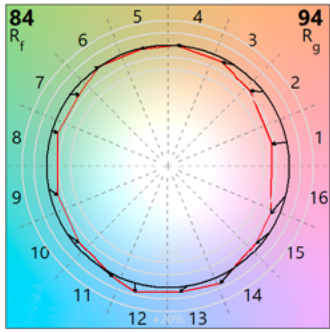
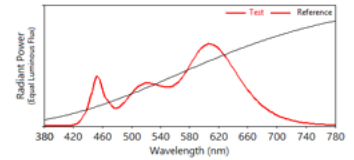
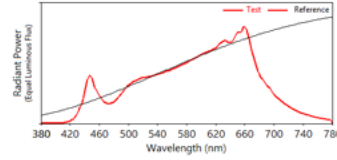
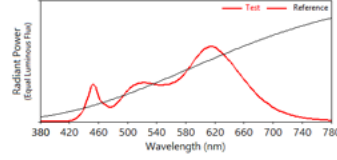
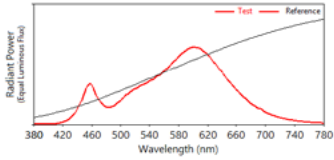

WARNING: Not for use in fully enclosed luminaires. Risk of electric shock. Use in an indoor, dry location only. This device is not intended for use with emergency exit fixtures or emergency exit lights. May not be compatible with all dimmers; please visit solais.com/dimming for up-to-date dimmer compatibility information.

NOTES: This device complies with Part 15 of the FCC Rule. This product may cause interference with other devices. If interference occurs, change the locations of the products involved. **Compatible on 120v systems.**



LUXIANCE®

Luxiance utilizes active cooling to remove heat from the LED system - allowing Solais LED lamps to operate cooler, resulting in superior life, light output, and performance.



X-CHANGEABLE

X-Changeable is our all-in-one technology that incorporates the optics, LEDs, driver and power within a replaceable module. This allows you to change the lumen output, color temperature, beam angle and trim color with ease.



THEROTTLE

Thermal Throttle – In the event that Solais products begin to overheat, they will undetectably dim themselves to protect your technology investments.



VIOLIGHT™

ViOLight radiates superior quality, enhancing colors in merchandise, making colors more vibrant and offering a truly competitive LED replacement for CMH-like crispness.